

Draft Final Report

**San Juan River Population Model
Documentation and Report**

Prepared for:

Southern Ute Indian Tribe

Bureau of Indian Affairs

and

San Juan River Recovery Implementation Program

Prepared by:

William J. Miller

Miller Ecological Consultants, Inc.

2111 S. College, Unit D

Fort Collins, CO 80525

and

Vincent A. Lamarra

Ecosystems Research Incorporated

975 South State Highway

Logan, UT 84321

May 19, 2006



**MILLER ECOLOGICAL
CONSULTANTS, INC.**

Table of Contents

INTRODUCTION	1
Conceptual Model	1
METHODS	5
Primary Producers	5
Secondary Producers	5
Detritus Biomass	6
Stable Isotope Analysis	6
Habitat Data	6
Fish Population Estimates	6
Specific Habitat Estimates	7
One Mile River Reaches	7
Mechanistic Model	7
RESULTS and discussion	9
Habitat	10
Water Quality and Flow	10
Primary Producers and Detritus	10
Macroinvertebrates	23
Trophic Relationships	36
Pikeminnow Bioenergetics Estimates	39
Model Development and Calibration	48
Model Execution	51
Model Runs	52
Sensitivity analysis	56
Conclusions	63
Recommendations	63
Literature Cited	64
APPENDIX A – Model Parameters And Data Source For Stella Model	67
APPENDIX B – Population Model Life History, Bioenergetics And Population Parameter Data	76
APPENDIX C – References	101
APPENDIX D – Fish Population Estimates 1998-2001	121
APPENDIX E – Flannelmouth Example Code	147

List of Tables

Table 1. Interrelationship matrix of ecosystem level parameters for the San Juan River.	4
Table 2. San Juan River population estimates by year and reach.	7
Table 3. The habitat flow relationships for runs, riffles and total low velocity habitats where $y = \text{area in m}^2$ and $x = \text{flow (cfs)}$.	11
Table 4. The average density of carbon in periphyton and detritus in the San Juan River in 1998-2000.	15
Table 5. A summary of the annual production estimates in the San Juan River for 1998-1999.	32
Table 6. The results of the stable isotope analysis conducted on ecosystem components in the San Juan River.	38
Table 7. Parameters used for Colorado pikeminnow bioenergetic simulations.	42
Table 8. Sources for parameters used in bioenergetic simulations for six predatory fish species.	43
Table 9. Estimates of available prey, and consumption of prey in the San Juan River.	46
Table 10. The estimate of the annual production of prey fish in the San Juan River assuming a Annual Turnover Ratio of 0.65.	47
Table 11. Comparison of 99% and 90% mortality of Age 0 Colorado pikeminnow.	56
Table 12. Predicted populations with Colorado pikeminnow and razorback sucker actual augmentation numbers 2000 – 2005.	62
Table 13. Predicted populations with Colorado pikeminnow and razorback sucker augmentation numbers as specified in the augmentation plans.	62

List of Figures

Figure 1. Conceptual trophic relationships for San Juan Population Model (arrow indicate direction of energy flow).s	2
Figure 2. Physical and biological interactions.	2
Figure 3. Stella model components.....	8
Figure 4. Example of Stella model coding.....	8
Figure 5. San Juan River discharge during sampling events.	9
Figure 6. The temporal distribution of periphyton biomass at three locations in San Juan River riffle habitat type.....	12
Figure 7. The temporal distribution of periphyton biomass at three locations in San Juan River run habitat type.....	13
Figure 8. The comparison of the average periphyton biomass for the study period (February 1998 to September 2000. Bars represent one standard error.	14
Figure 9. The amount of carbon produced and consumed in the benthic community in the San Juan River in February, 1998.....	16
Figure 10. The rate of photosynthesis and respiration expressed as grams of carbon per meter squared per hour of the benthic community in the San Juan River in February, 1998.....	17
Figure 11. The relationship between ambient light and photosynthesis in the San Juan River in February 1998.....	19
Figure 12. The temporal distribution of detritus biomass at three locations in San Juan River riffle habitat type.....	20
Figure 13. The temporal distribution of detritus biomass at three locations in San Juan River run habitat type.....	21
Figure 14. The comparison of the average detritus biomass for the study period (February 1998 to September 2000). Bars represent one standard error.	22
Figure 15. The density by size class of Hydropsyche in the San Juan River at RM 188 over 20 sample dates.....	24
Figure 16. The biomass by size class of Hydropsyche in the San Juan River at RM 188 over 20 sample dates.....	25
Figure 17. The biomass estimates of each major group of macroinvertebrates at RM 104 in the San Juan River.	26
Figure 18. The average per cent distribution of the five major groups of invertebrates at RM 104 in the San Juan River between 2/1998 and 9/2000.....	27
Figure 19. The biomass estimates of each major group of macroinvertebrates at RM 147 in the San Juan River.	28
Figure 20. The average per cent distribution of the five major groups of invertebrates at RM 147 in the San Juan River between 2/1998 and 9/2000.....	29
Figure 21. The biomass estimates of each major group of macroinvertebrates at RM 188 in the San Juan River.	30
Figure 22. The average per cent distribution of the five major groups of invertebrates at RM 188 in the San Juan River between 2/1998 and 9/2000.....	31
Figure 23. The per cent distribution of the annual production (1.64 gms C/m ² /year) by invertebrate group at RM 104 in the San Juan River.....	33

Figure 24. The per cent distribution of the annual production (2.18 gms C/m²/year) by invertebrate group at RM 146 in the San Juan River..... 34

Figure 25. The per cent distribution of the annual production (4.11 gms C/m²/year) by invertebrate group at RM 188 in the San Juan River..... 35

Figure 26. The distribution of ecosystem components in the San Juan River relative to nitrogen and carbon stable isotopes 37

Figure 27. Predicted and observed weights (g) of Colorado pikeminnow captured in the San Juan River from 1987-1997. 40

Figure 28. Theoretical Colorado pikeminnow age class distribution. 40

Figure 29. Total biomass (kg) of each Colorado pikeminnow age class. 41

Figure 30. Yearly consumption rate (g) for seven piscivorous species using the Wisconsin model to simulate the consumption requirements..... 41

Figure 31. Total biomass (kg) for reaches 3 and 6 of the San Juan River. 45

Figure 32. Colorado pikeminnow yearly consumption (kg/mile/year) and available prey biomass (kg/mile) for Reach 3 of the San Juan River. 45

Figure 33. Colorado pikeminnow yearly consumption (kg/mile/year) and available prey biomass (kg/mile) for Reach 6 of the San Juan River. 46

Figure 34. Example population dynamics for fish species with various interrelated parameters..... 49

Figure 35. A more detailed view of the fish numeric population portion showing transfer from spawning to juvenile. 49

Figure 36. The complete population model for one selected fish species (flannelmouth sucker) in the model..... 50

Figure 37. Speckled dace population estimate for riffle habitat, Reach 6, 1998. 53

Figure 38. Flannelmouth sucker population estimate for riffle habitat, Reach 6, 1998. 54

Figure 39. Flannelmouth sucker population estimate (number per mile) for Reach 6, 1998..... 55

Figure 40. Comparison of model versus monitored bluehead sucker juvenile abundance. 57

Figure 41. Comparison of model versus monitored bluehead sucker adult abundance... 57

Figure 42. Comparison of model versus monitored flannelmouth sucker juvenile abundance. 58

Figure 43. Comparison of model versus monitored flannelmouth sucker adult abundance. 58

Figure 44. Model predicted abundance for native bluehead (JuvB and Adlt B) and flannelmouth (Juv B and Adlt B) sucker species 2001-2010. 59

Figure 45. Comparison of monitored versus modeled razorback sucker populations. 59

Figure 46. Model predicted razorback sucker adult population with existing augmentation and with augmentation as specified in augmentation plan.2001-2010. 60

Figure 47. Model predicted Age 6+ Colorado pikeminnow population with existing augmentation and with augmentation as specified in augmentation plan.2001-2010. 60

INTRODUCTION

The San Juan River Population Model study began in 1998 with development of a conceptual model for the river aquatic ecosystem and initial population estimates for two reaches of the river. The study has evolved since 1998 and focused on both gathering calibration data for development of the population model as well as coding the model from 1998 through 2001. Since 2002, the major effort has been performing model runs and model calibration using new data collected annually by researchers during the monitoring program from 2002 to the present. The major goal of the initial work was to determine the ultimate carrying capacity of the Colorado pikeminnow based upon the observed fish densities within the San Juan River. Initially, it was felt that this “biologically” based density would be a guideline toward recovery.

Simulation models have long been used in conjunction with field or laboratory experiments to develop knowledge and to form management decisions for ecosystems. The San Juan River Population Model follows the concepts and guidelines shown in many of the ecological modeling publications, in particular Grant et al. (1996). The basic concept of modeling is to develop a conceptual framework for the specific area or ecosystem of interest, have a conceptual abstraction of that ecosystem, which is then transformed into a deterministic relationship for each of the system components and developed into a simulation model with either a programming software package or a programming language. For the San Juan River Population Model, the original conceptual model was developed to identify the major components of the system and during the development of recovery goals for razorback and Colorado pikeminnow, the mechanistic relationships were developed that are now in the simulation model. The purpose of the conceptual model was to identify cause and effect using basic box and arrow diagrams that showed relationships between the physical components of the system and the biological components of the system (Figures 1 and 2). There are two primary components modeled with the ecosystem model: the physical system which includes habitat, discharge, water temperature, and suspended solids (turbidity); the second component was a biological component which includes the various trophic levels from primary up through top predator and shows the relationship between energy flow through the system. It also includes reproduction, growth and mortality of the biological components of the system.

CONCEPTUAL MODEL

The San Juan River conceptual model consisted of four trophic levels within the system and the physical variables that form the environment for those trophic levels. The physical system included habitat, as determined by habitat mapping during fall surveys and in particular the amount of riffle and run habitat which are the most abundant in the system. In addition, discharge information and the relationship between how habitat changes with the amount of water or discharge in the river was important to quantifying change in habitat with flow which affected the amount of area for both primary producers up through the top predator. Water temperature affects growth of primary producers and also growth of the fish species of interest when they are in the river. Water temperature

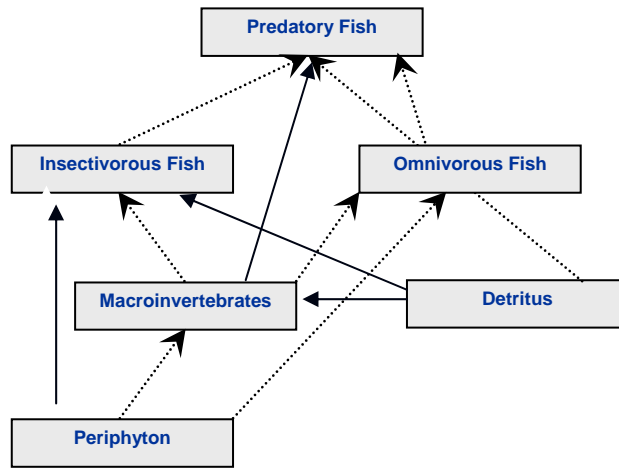

Figure 1. Conceptual trophic relationships for San Juan Population Model (arrow indicate direction of energy flow).s

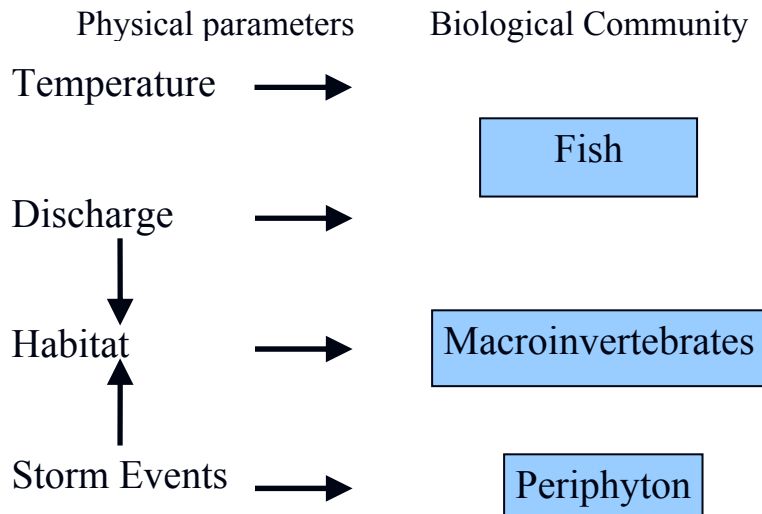

Figure 2. Physical and biological interactions.

was included in the model and used to determine growth rates for the biological species in the system. The final physical variable used in the model is the suspended solids or turbidity since the large thunderstorms in the monsoon season in the San Juan Basin can produce short durations of high intensity rainfall. It is one component of the system that can reset the primary productivity to near zero when large suspended solids

concentrations come into the river with thunderstorm inflows. This has been shown both in the biological monitoring data and in the physical monitoring data with the thunderstorm activity within the basin.

The model incorporates several biological trophic level interactions and the physical processes that might regulate their biomass and productivity. Primary producers, detritus, primary consumers, secondary consumers, and predators are represented and were initially modeled. An interactive matrix was built which represented the specific fish species within the San Juan River, and their direct interrelationships (Table 1) with other ecosystem components. This matrix directed the final model interactions.

Primary producers in the river are periphyton and the detritus subsystem, which are affected by water temperature, discharge and suspended solids. These physical parameters affect the amount of surface area they can occupy, (biomass levels) as well as the rate of productivity. The turbidity or suspended solids in the system can scour periphyton from the rocks and decrease the amount of available productivity to primary consumers and secondary producers.

Macroinvertebrates are the second trophic level in the system. They feed off the primary producers and detritus in the system, (both instream detritus and the allochthonous material that comes from riparian leaf fall).

The third level for the trophic system includes the insectivorous fish and omnivorous fish. This group feeds on the lower trophic levels of both periphyton and macroinvertebrates. The final level is predatory fish in the system which generally feed on lower trophic levels of macroinvertebrates and the insectivorous and omnivorous fish.

The structure of the model incorporates two basic forms. The first is the calculation of the numeric numbers of organisms at any timestep. This process uses basic population dynamics. Once the population densities are generated, the model then uses bioenergetic calculations too determine the associated impacts to adjacent trophic levels through foodweb interactions.

Population dynamics for the fish species included the basic components of stocks of each lifestage of fish which include larval, juvenile and adult lifestages. It also includes the reproduction, mortality and growth for each fish species. There is a general flow in the system from spawning and hatching through the younger lifestages and then on to the adult lifestages and back through the reproductive life cycle. Important components of these simulations are the natural and predation mortality that occurs on each of these species, the number of eggs produced, the sex ratio of male to female fish, and the hatching success of the eggs when fertilized. Mortality rates for the young lifestages are included as well as for each subsequent lifestage up through adults.

Table 1. Interrelationship matrix of ecosystem level parameters for the San Juan River.

Species	Functional group	Food source	Competitor	Habitat	Predator
Phytoplankton	Primary producer	Water nutrients	Scour/turbidity	Stream surface	Inverts/scrapers
Inverts	Secondary	Phytoplankton/detritus	Scour/turbidity	Cobble	Dace/suckers/catfish/carp
Dace	Secondary/omnivore	Inverts/algae	Juvenile catfish	Riffles	Catfish-roundtail chub-pikeminnow
Bluehead	Scraper-secondary	Algae-inverts	Scour/turbidity	Riffle pool interface	Catfish-roundtail chub-pikeminnow
Flannelmouth	Grazer-secondary	Algae-detritus-inverts	Carp –juvenile catfish	Runs – pools	Catfish-pikeminnow
Roundtail	Tertiary-predator	Inverts – small bodied fish	Catfish – pikeminnow	Runs – pools	Pikeminnow – catfish
Pikeminnow	Keystone predator	Fish to 300 mm	Catfish	Runs/eddy/pools/chutes(spawning)	Catfish-red shiner – roundtail
Catfish	Predator	Small fish, inverts, algae	Pikeminnow	Runs pools	Mechanical removal
Carp	Grazer	Algae-inverts-detritus	Flannelmouth	Runs	Pikeminnow-catfish

These common components were developed for each species modeled in the San Juan River Population Model (SJ RPM). San Juan specific data were used where available to develop the necessary information. Where that information was lacking, an extensive literature review was conducted to develop basic information on life history requirements and life history components from the published and unpublished literature.

The second associated submodel was the bioenergetic dynamics. Data needed were the physiological characteristics and the associated mathematical coefficients relative to fish species in the San Juan River. The computer program Fish Bioenergetics v.3.0 (Hansen et al. 1977) was initially used for bioenergetic simulations. This model uses predictive equations for estimating grams of prey consumed based upon body weight (grams) of the consumer and the associated growth increments (grams). For each species modeled in the San Juan, the input parameters for the consumption, respiration, and egestion/excretion functions were selected from literature values for those species or from surrogate species with similar thermal requirements and trophic position. A summary of the parameters used for the bioenergetic simulations is presented in Appendix B.

Two key species in the model from the management standpoint are the razorback sucker and Colorado pikeminnow, both of which are listed as endangered. These two species are long-lived fish which makes the modeling environment well suited to development of management scenarios since their lifespan is thirty to as much as fifty years. Developing

cause and effect relationships from short-term information, as well as from literature that has been developed since the 1960s, aids in formulation of the mechanistic relationships of the model.

METHODS

The following section describes the methods and procedures used to collect the empirical data necessary to calibrate the SJRPM. These data vary spatially and temporally within the San Juan River based upon the intensity of data needed for calibration (e.g. monthly for invertebrates while only annually for fish).

Two ecosystem components (primary and secondary producers) were quantified in the San Juan River at three locations (RM 104, RM 147, and RM 188) between February 1998 and September 2000. Samples were collected 20 times at roughly monthly intervals excluding high flow months (May and June). In addition, at each location and time period, both riffles and runs were sampled.

In addition to the temporal monitoring, a synoptic survey in the San Juan River (RM 188 to RM 58) was undertaken in 1998. The purpose of this survey was to obtain stable isotope signatures of the major ecosystem components to establish the trophic structure of the aquatic community.

PRIMARY PRODUCERS

Primary producers were quantified by measuring *in situ* concentrations of chlorophyll *a* pigments. Periphyton was collected from cobble sized rocks located in a representative riffle and run habitat within the same river mile. A one centimeter diameter circle was scraped on triplicate rocks and returned to the laboratory for analysis. Data were calculated as mg Chlorophyll *a* per square meter. Chlorophyll *a* content of these samples was used as a measure of periphyton biomass.

In addition to the structural biomass parameters noted above, an *in situ* primary production experiment was undertaken in May, 1998 in order to quantify the rate of primary production occurring in the San Juan River. Production/respiration chambers were placed in the River at RM 158. Within each duplicate chamber, a representative amount of ambient substrate was placed in each chamber. The chambers were sealed and placed in the river at the same depth (0.25 meter) as the original. YSI oxygen probes and LYCOR light sensors were placed in each chamber and recorder data at 15 minute intervals. The chambers were refreshed every 4 hours over a 72 hour timeframe in order to prevent nutrient limitations.

SECONDARY PRODUCERS

Benthic macroinvertebrates were collected at each sample location where periphyton collections were made using a modified Hess sampler. Triplicate samples were preserved in alcohol and returned to the laboratory for analysis. Once in the laboratory, specimens

were removed from the associated organic matter and identified to species. For each dominant group, one hundred individuals were measured for total length. A length-weight relationship was established for each group of macroinvertebrates so that total counts could be converted to biomass. Data were expressed as grams or numbers per meter squared.

DETRITUS BIOMASS

Organic material removed from the macroinvertebrate samples were dried and weighed to provide estimates of coarse particulate organic matter. This biomass of detritus was expressed as grams per meter squared.

STABLE ISOTOPE ANALYSIS

In 1998, fifteen locations between RM 180 and RM 58 were sampled for stable isotopes (N15 and C13). At each location, terrestrial leaf litter was collected for the major riparian vegetation types present in the San Juan River floodplain (willow, cottonwood, tamarisk, Russian olive, and grasses). Aquatic ecosystem components collected at each site included native fish species (flannelmouth sucker, bluehead sucker, speckled dace, and razorback sucker and non native fish species (brown trout, channel catfish, and red shiner). In addition algal periphyton, benthic detritus (course through ultra fine sizes) and particulate organic drift (course to ultra fine sizes) were collected and returned to the laboratory. Samples were frozen in the field and returned to the laboratory. Samples preparation included air drying and compositing samples across all location. Composited samples were then sent to the Utah State University Water Research Laboratory for stable isotope (13C and 15N) analysis using a mass spectrometer. Data are reported as units/mass.

HABITAT DATA

Data used in the modeling effort described in this report came from the monitoring data collected since 1992 by Bliesner and Lamarra (2005). Data were reduced to the surface area (meter squared) per river mile for both run and riffle habitat. Regression relationships between flow and habitat area for each geomorphic reach were developed using Excel spreadsheet statistical functions.

Flow and water quality data used in the model were obtained from existing information. Flow data were obtained from the USGS for the period of record. Turbidity data was obtained from the San Juan River Recovery Implementation Program database.

Fish Population Estimates

Population estimates were made from 1998 through 2001 (Table 2). The population estimate data was used for development of biomass estimates by river reach. In each reach the following methods were be employed to develop population estimates.

Table 2. San Juan River population estimates by year and reach.

Year	Reach 3	Reach 4	Reach 5	Reach 6	Reach 7
1998 ¹	X			X	
1999	X	X	X	X	X
2000	X			X	
2001	X			X	

¹Initial data collection, one riffle and shoreline run sampled in each reach.

Specific Habitat Estimates

In each river reach during 1999, 2000, and 2001, three riffles and three shoreline run habitats were selected as locations for multiple pass removal location for small bodied fish population estimates. Three to five removal passes were made in each selected habitat. The number of removal runs required was determined by the number of fish collected each pass. The riffle and run habitat was sampled by blocking the area with seines as follows. A 20 meter (m) long small mesh seine was placed parallel to the river bank during sampling and a 8 m long bag seine positioned at the downstream end of the blocking net. Stunned fish were captured in hand held dip nets and the block seine. Surface area sampled and seconds electrofished were recorded for each habitat. Quantitative periphyton and macroinvertebrate samples were collected at each riffle and shoreline run sampling location.

One Mile River Reaches

A one mile section was selected in each of the five river reaches for population estimates. At least four removal passes were made in each one mile reach using three electrofishing rafts. All removal passes in any one mile reach were made on the same day. All fish captured, except Colorado pikeminnow (*Ptychocheilus lucius*) and razorback sucker (*Xyruachen texanus*) were retained in separate holding nets and processed after all passes are completed. The rare fish were weighed measured and released at the end of the pass in which they were collected. Prior to release these fish were checked for PIT tags and if not tagged, a PIT tag was placed in all fish of appropriate size.

Mechanistic Model

The simulation software currently used for the San Juan River Population Model is the STELLA software developed by IC Systems. This software produces a graphical interface with underlying equations for the relationships between each of the model components.

Stella is a modeling environment that uses a graphical user interface to characterize the interactions between system components. The basic components used in Stella are stocks (the basic population), flows (either inflow to or outflow from the stocks) and converters (these control the rate of the flows)(Figure 3).

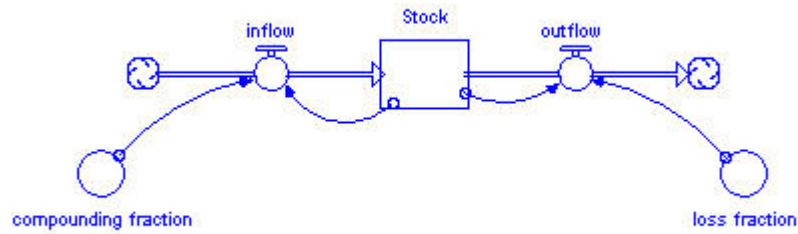

Figure 3. Stella model components.

Each of these graphical components has an equation or number associated with it. During model construction, the modeler is prompted for the number, functional relationship or equation for each model component. As such, there is an explicit set of model code associated with each model component (Figure 4).

```

□ Stock(t) = Stock(t - dt) + (inflow - outflow) * dt
INIT Stock = 10
INFLOWS:
  -⊕ inflow = Stock*compounding_fraction
OUTFLOWS:
  -⊕ outflow = Stock*loss_fraction
○ compounding_fraction = .25
○ loss_fraction = .125

```

Figure 4. Example of Stella model coding.

RESULTS AND DISCUSSION

The collection, processing and analysis of the dynamics of ecosystem components in the San Juan River had two major objectives. The first was to gain an understanding of the complexity of the food web to be modeled. Inspection of the magnitude of primary producers and detritus biomasses provided insight into the food base in the San Juan River for higher trophic levels. In addition, primary production experiments looked at the rate with which primary producers were replacing biomass (i.e. primary production). Detritus inflows were not measured as part of this modeling effort. Personal observations by the authors indicated that during storm events substantial amounts of detritus entered the San Juan River and added to the particulate drift component. The residual detritus quantified in this study was only a small component of the total detritus in the San Juan River. The sample dates for the periphyton and macroinvertebrate study can be seen with the daily flows in Figure 5.

Because the model is based on bioenergetics, with food resources for a species dependent upon another trophic level, the location of major ecosystem components were placed into their respective trophic levels using stable isotope signatures.

The second major reason for the collection of site specific biological data was to provide empirical data by which to calibrate the model. Macroinvertebrate densities and biomass data as well as the fish density estimates were found to be especially useful.

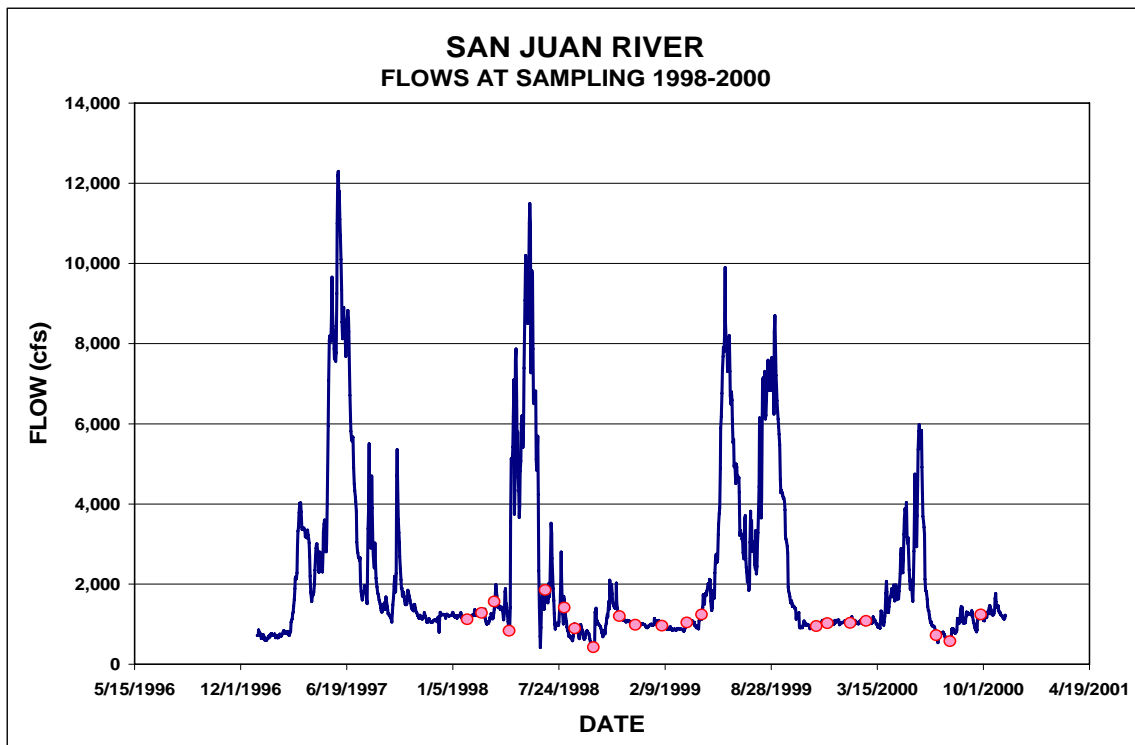

Figure 5. San Juan River discharge during sampling events.

HABITAT

The habitat data (surface area in m² per reach) was summarized from data collected at different flows between 1991 and 2004. The data were used in non-linear regressions. The results of those regressions can be seen in Table 3.

WATER QUALITY AND FLOW

In the model simulations, water quality (turbidity) and flow data were based upon the period 1992 to 2004. For the first three years, simulated (2001-2004), site specific daily data was used. For the years beyond 2004, average daily data (calculated from 1992-2002) was used as inputs for flow, temperature and turbidity. Data are provided in Appendix B.

PRIMARY PRODUCERS AND DETRITUS

The major primary producer in the San Juan River is periphytic algae. The nature of the bed substrate and water velocities exclude other rooted aquatic plants from growing in abundance. Data were collected 20 times at three sites, between February 1998 and September 2000. The data are shown for these sites for the riffle (Figure 6) and run (Figure 7) habitat types. Inspection of the data for the riffle sites at each river location in Figure 2 and Figure 4 as well as the analysis in Table 1 indicates that the sites had similar temporal distributions with the average concentration of Chl *a* not significantly different between sites. The periphyton biomass data from the run habitats had some significant differences between sites (Figure 8), however, these differences were caused by a few data points. As can be seen in Figure 3, the sites had a good degree of similarity in there temporal patterns.

Except for two dates at two different locations, the periphyton biomass estimates for riffles and runs were similar and not significantly different when averaged river wide (Table 4). This has important consequences to the model in that a single subroutine can be used for all habitats. The only difference between the two habitats is depth which can affect photosynthesis via light penetration. This was investigated using 24 hour *in situ* chamber experiments.

The periphyton data collected in the San Jun River was similar in densities when compared to the upper Colorado River (Osmundson et al. 2002). The habitat differences found in the Colorado River were also similar to the San Juan River when looking at similar geomorphic sections between the two rivers.

In February 1998, *in situ* field experiments were undertaken to quantify the amount of primary production occurring in the San Juan River benthic community. The study was done at three locations (RM 188, RM 147 and RM 104). At each location, duplicate chambers were used. Net primary production and respiration were measured based upon the diurnal oxygen method (Welch 1968; Britton and Greeson 1987). An example of the raw data generated from the P/R chambers for RM 188 can be seen in Figure 9 and 10.

Table 3. The habitat flow relationships for runs, riffles and total low velocity habitats where y= area in m² and x=flow (cfs).

RUNS:

Model Reach 1	$y = -0.00827x^2 + 165.27695x + 1418788.03824$
Model Reach 2	$y = -0.01896x^2 + 216.12351x + 2533988.52574$
Model Reach 3	$y = -0.02670x^2 + 581.00056x + 3036322.94238$
Model Reach 4	$y = -0.08372x^2 + 1159.98680x + 4721119.75123$
Model Reach 5	$y = -0.03602x^2 + 340.38991x + 560429.07811$

RIFFLES:

Model Reach 1	none
Model Reach 2	$y = -0.0242x^2 + 117.45x + 345021$
Model Reach 3	$y = -0.000032x^3 + 0.260786x^2 - 420.661057x + 417593.551251$
Model Reach 4	$y = 644223e^{-0.0004x}$
Model Reach 5	$y = 123836e^{-0.0004x}$

ALL LOW VELOCITY HABITAT

Model Reach 1	none
Model Reach 2	$y = -0.0242x^2 + 117.45x + 345021$
Model Reach 3	$y = -0.000032x^3 + 0.260786x^2 - 420.661057x + 417593.551251$
Model Reach 4	$y = 644223e^{-0.0004x}$
Model Reach 5	$y = 123836e^{-0.0004x}$

SAN JUAN RIVER PERIPHYTON BIOMASS IN RIFFLES

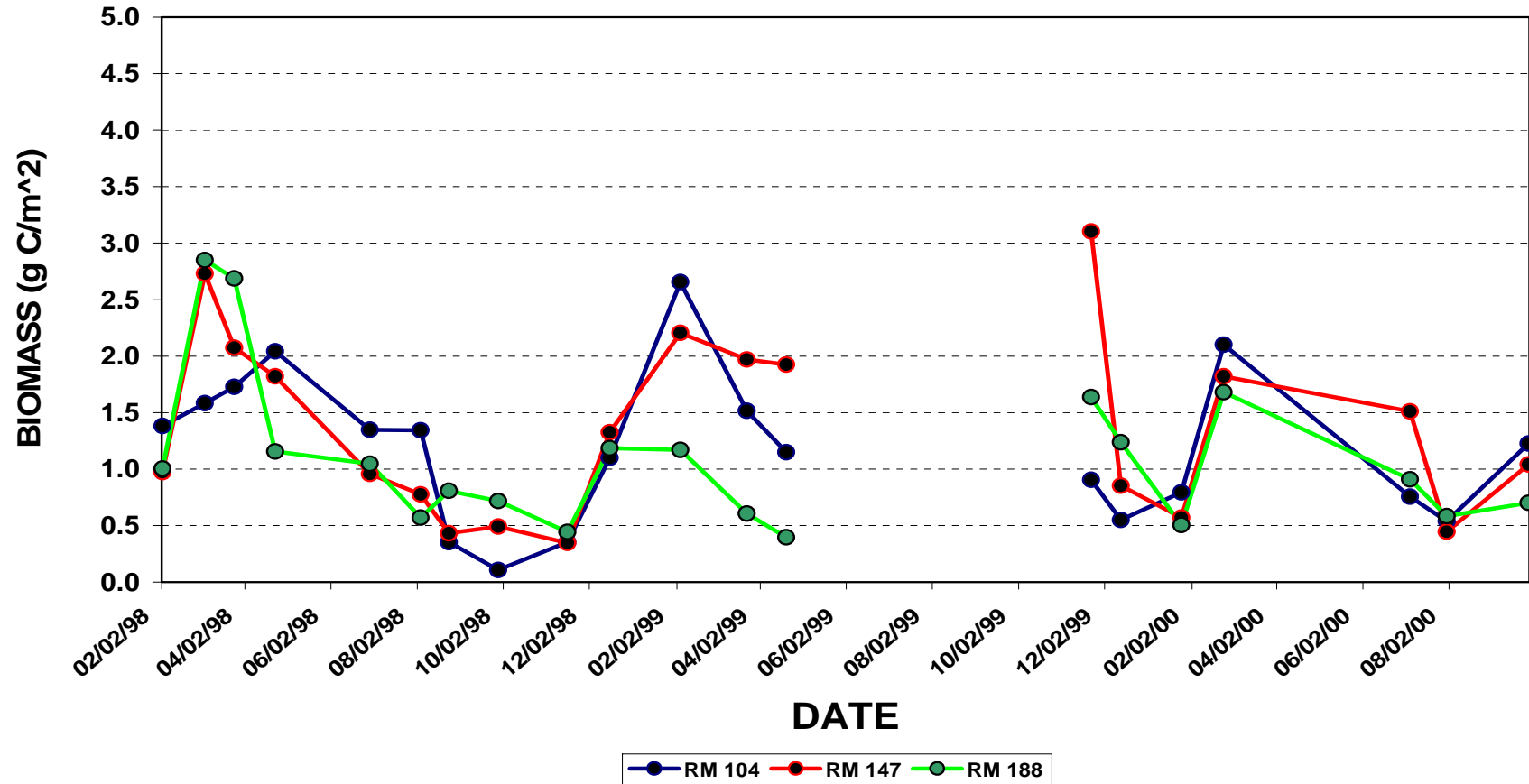

Figure 6. The temporal distribution of periphyton biomass at three locations in San Juan River riffle habitat type.

SAN JUAN RIVER PERIPHYTON BIOMASS IN RUNS

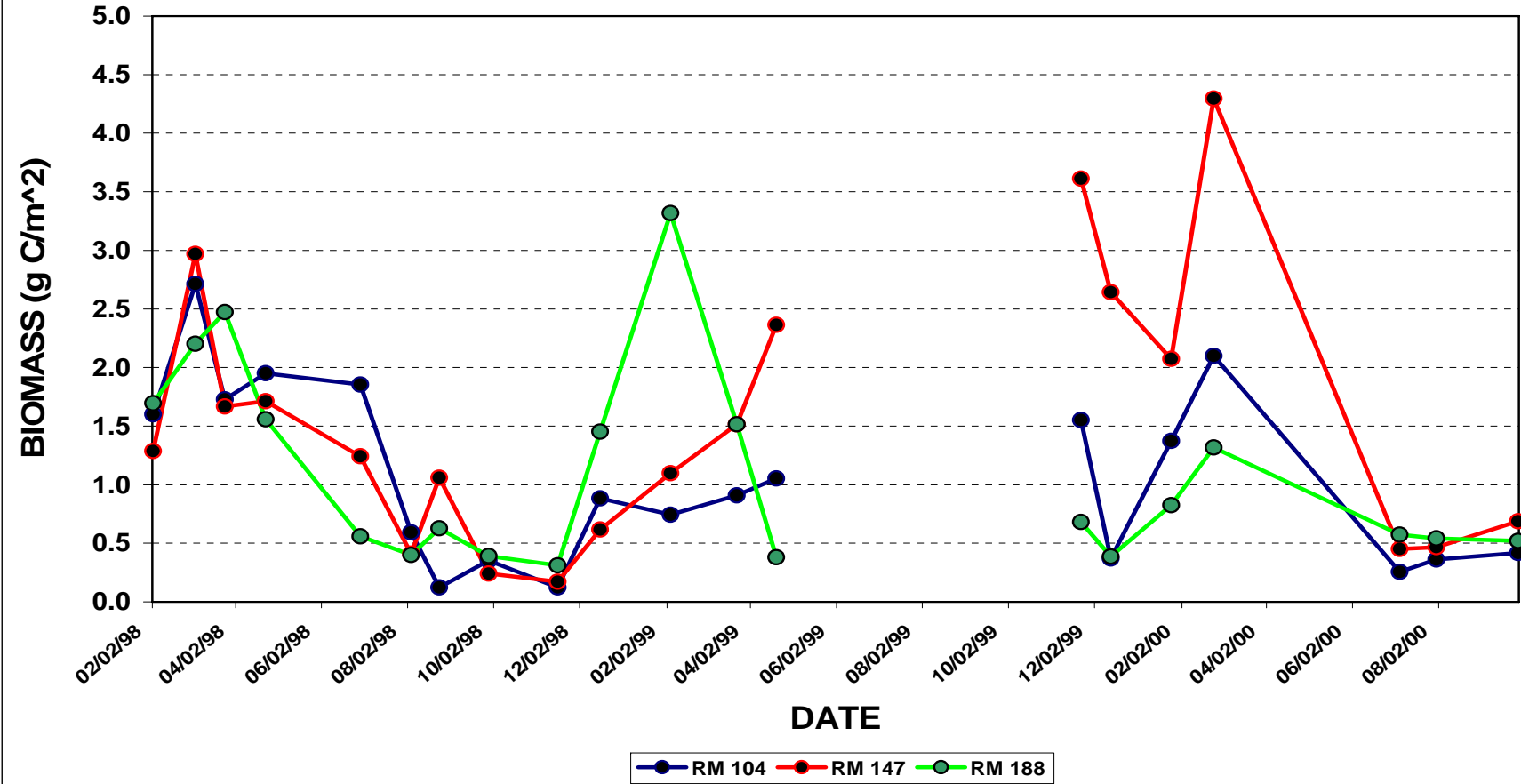

Figure 7. The temporal distribution of periphyton biomass at three locations in San Juan River run habitat type.

SAN JUAN RIVER PERIPHYTON BIOMASS COMPARISONS

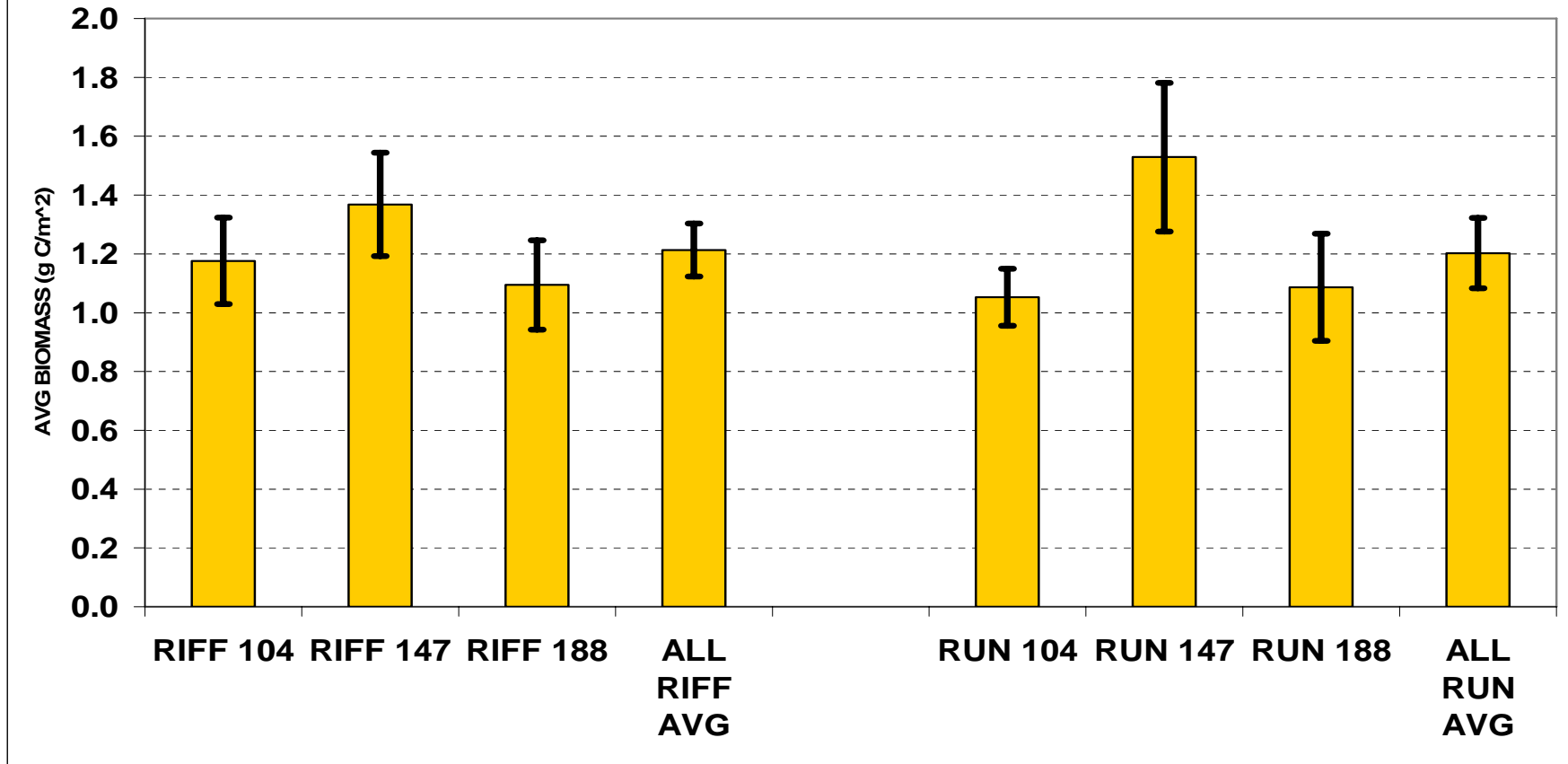

Figure 8. The comparison of the average periphyton biomass for the study period (February 1998 to September 2000). Bars represent one standard error.

Table 4. The average density of carbon in periphyton and detritus in the San Juan River in 1998-2000.

PERIPHYTON	(g C/m ²)		DETRITUS	(g C/m ²)	
	AVG	SE		AVG	SE
RIFF 104	1.18	0.15	RIFF 104	15.86	2.15
RIFF 147	1.37	0.18	RIFF 147	36.26	7.09
RIFF 188	1.09	0.15	RIFF 188	36.58	8.86
ALL RIFF AVG	1.21	0.09	ALL RIFF AVG	29.08	3.95
RUN 104	1.05	0.10	RUN 104	11.49	1.35
RUN 147	1.53	0.25	RUN 147	12.40	1.30
RUN 188	1.09	0.18	RUN 188	33.06	10.85
ALL RUN AVG	1.20	0.12	ALL RUN AVG	18.98	3.85

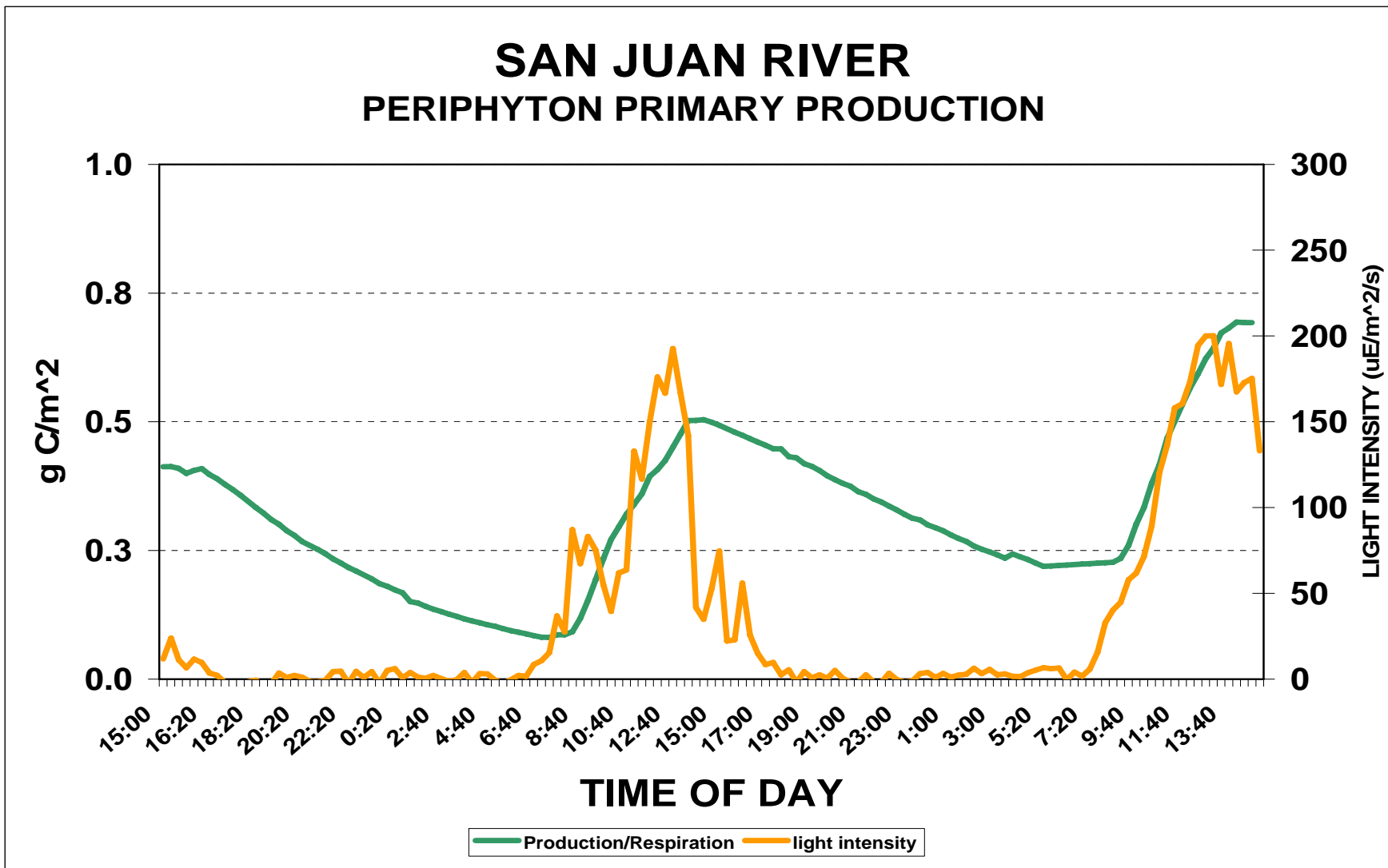

Figure 9. The amount of carbon produced and consumed in the benthic community in the San Juan River in February, 1998.

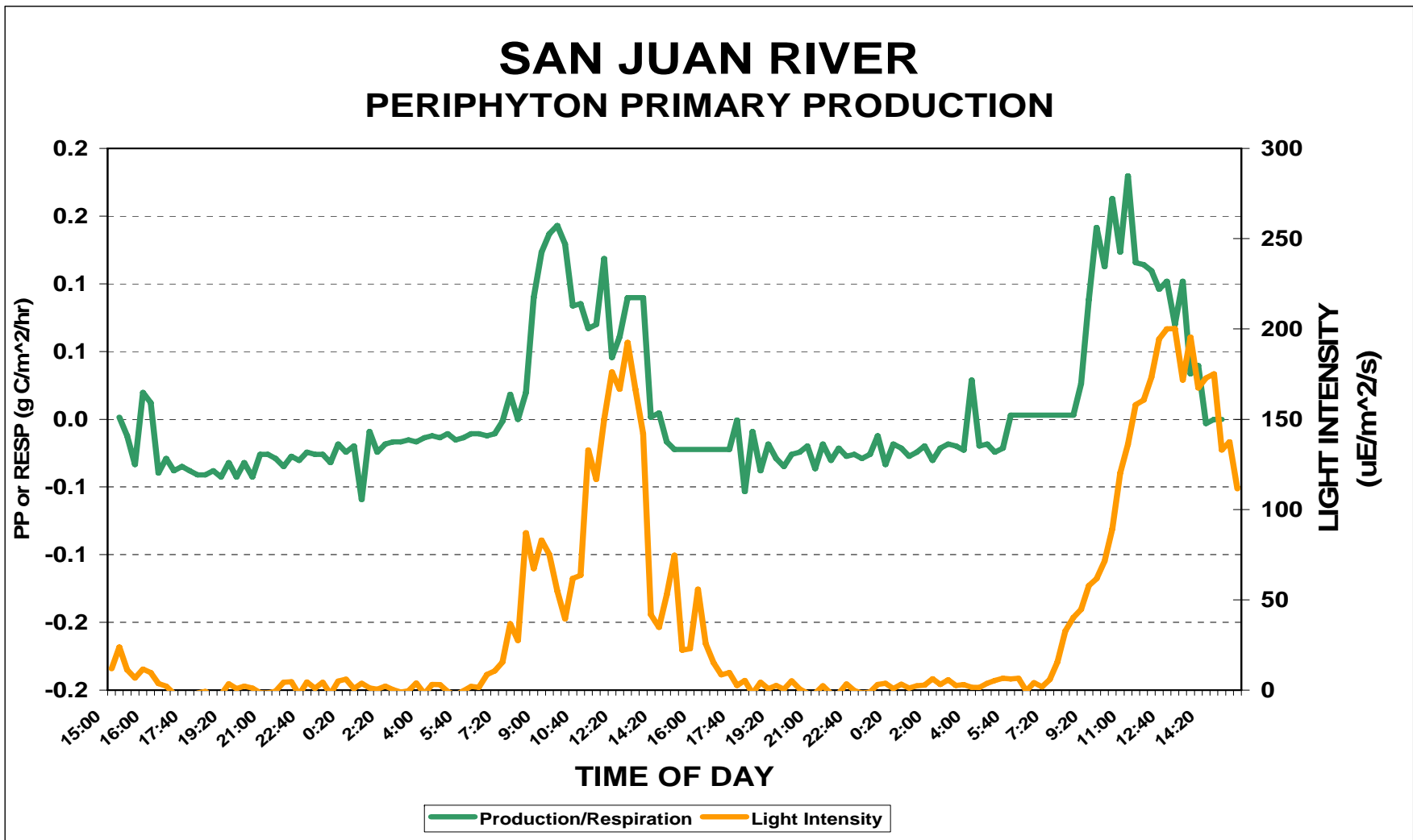

Figure 10. The rate of photosynthesis and respiration expressed as grams of carbon per meter squared per hour of the benthic community in the San Juan River in February, 1998.

The experiments were run over two consecutive 24 hour periods (duplicate days) as well as duplicate chambers. The oxygen evolution in the chambers were used to calculate the net community production, community respiration and gross community production in units of grams dry weight produced (or consumed) per meter squared or per gram carbon per day. These data were then used to make several production index estimates. Firstly, using this production data as well as the density of algae in grams of carbon for the February 1998 data at RM 188, we calculated that the turnover rate of primary production (in units of carbon) to be on the order of 45 days. In a similar analysis, the turnover rate for carbon at RM 147 was 33 days and for RM 104, 136 days. River-wide the average turnover rate of the primary producer community was 34 days which is based upon the net production estimates and algal biomass estimates over the entire study period. Secondly, an annual net production estimate expressed as grams carbon per meter squared per day was made using the instantaneous production rate per gram carbon and the independent biomass data. River wide, the average annual net production was found to be approximately 0.44 ± 0.23 (± 1 SE) grams carbon per meter squared per day. The range encountered (0.38 to 1.57 g carbon per meter squared per day) was in good agreement with other studies on other rivers (Wright and Mills 1967; Westlake 1963; King and Ball 1966).

The third analysis undertaken with the primary production experiments was to develop a photosynthetic irradiance curve in order to infer photosynthetic efficiency of the benthic algae in the San Juan River. An example of this data for RM 188 can be seen in Figure 11. This analysis indicates that peak photosynthesis occurred prior to full sunlight (100-125 $\mu\text{E}/\text{m}^2/\text{s}$). This would indicate that these algae were adapted to low light intensities. This is consistent with the observations that the San Juan River is typically turbid with limited light penetration. The data described for the benthic algal community indicates that primary production in runs is probably confined to shorelines of the river but present throughout the riffle habitats.

The standing crop of benthic detritus was also measured as part of the collection of data for conceptual model development and model calibration. The data (which was collected at the same locations and times as the periphyton data) can be seen in Figures 12 and 13 for riffles and runs. The standing crop (biomass) of organic detritus, also known as coarse particulate organic matter (CPOM) was higher in the riffles compared to the runs and tended to decrease with distance downstream. Inspection of Table 4 and Figure 14 shows that for the riffle community, the river wide average detritus biomass was approximately 29 grams carbon per meter squared compared with only 19 grams carbon per meter squared in run habitats. The differences were statistically significant. As noted previously, the detritus production rates (inflowing mass) were not determined. Because frequent storm events occur in the basin and observations by the authors, detrital inflows were deemed to be extensive.

SAN JUAN RIVER PERIPHYTON PRIMARY PRODUCTION

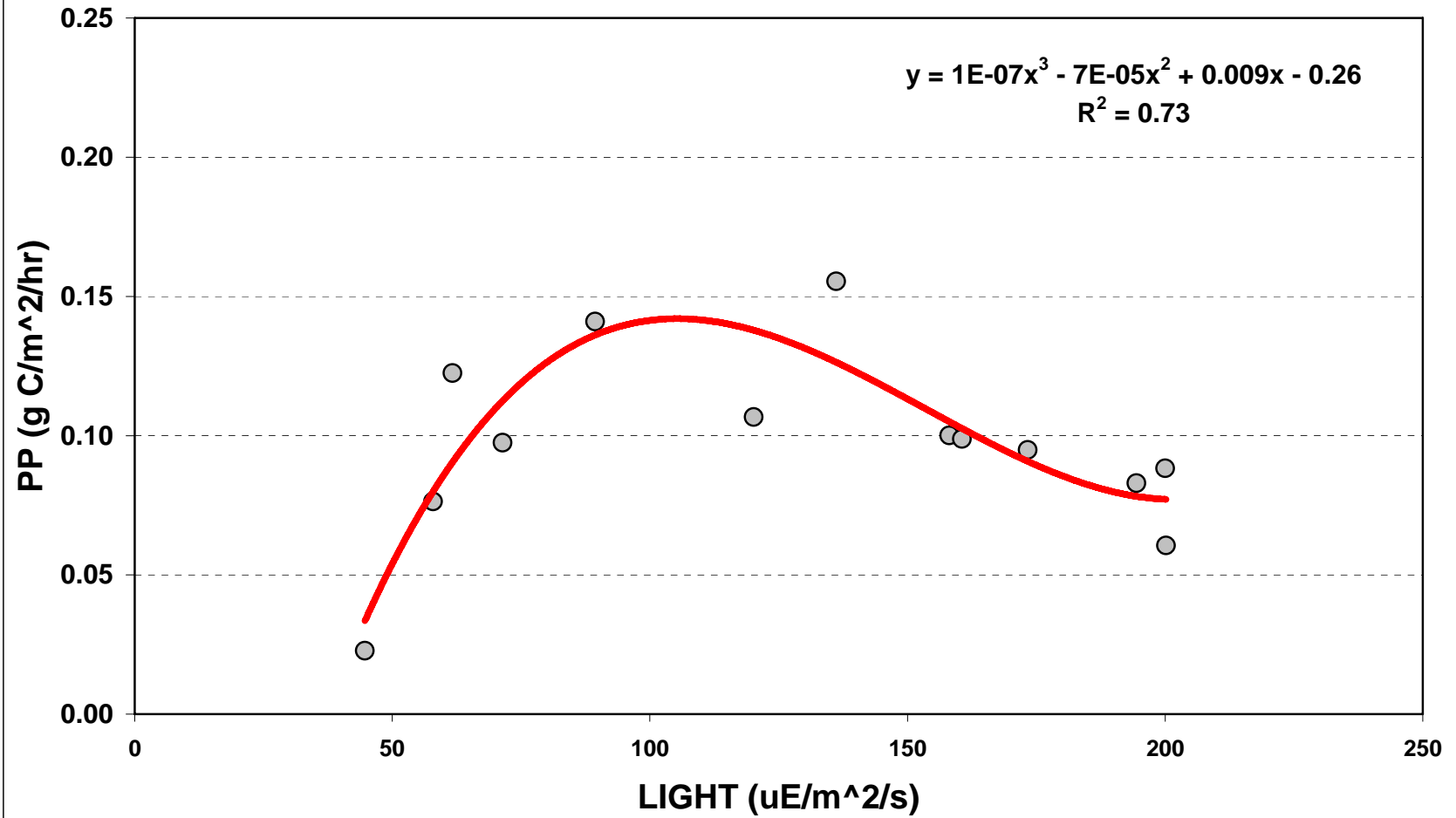

Figure 11. The relationship between ambient light and photosynthesis in the San Juan River in February 1998.

SAN JUAN RIVER DETRITUS BIOMASS IN RIFFLES

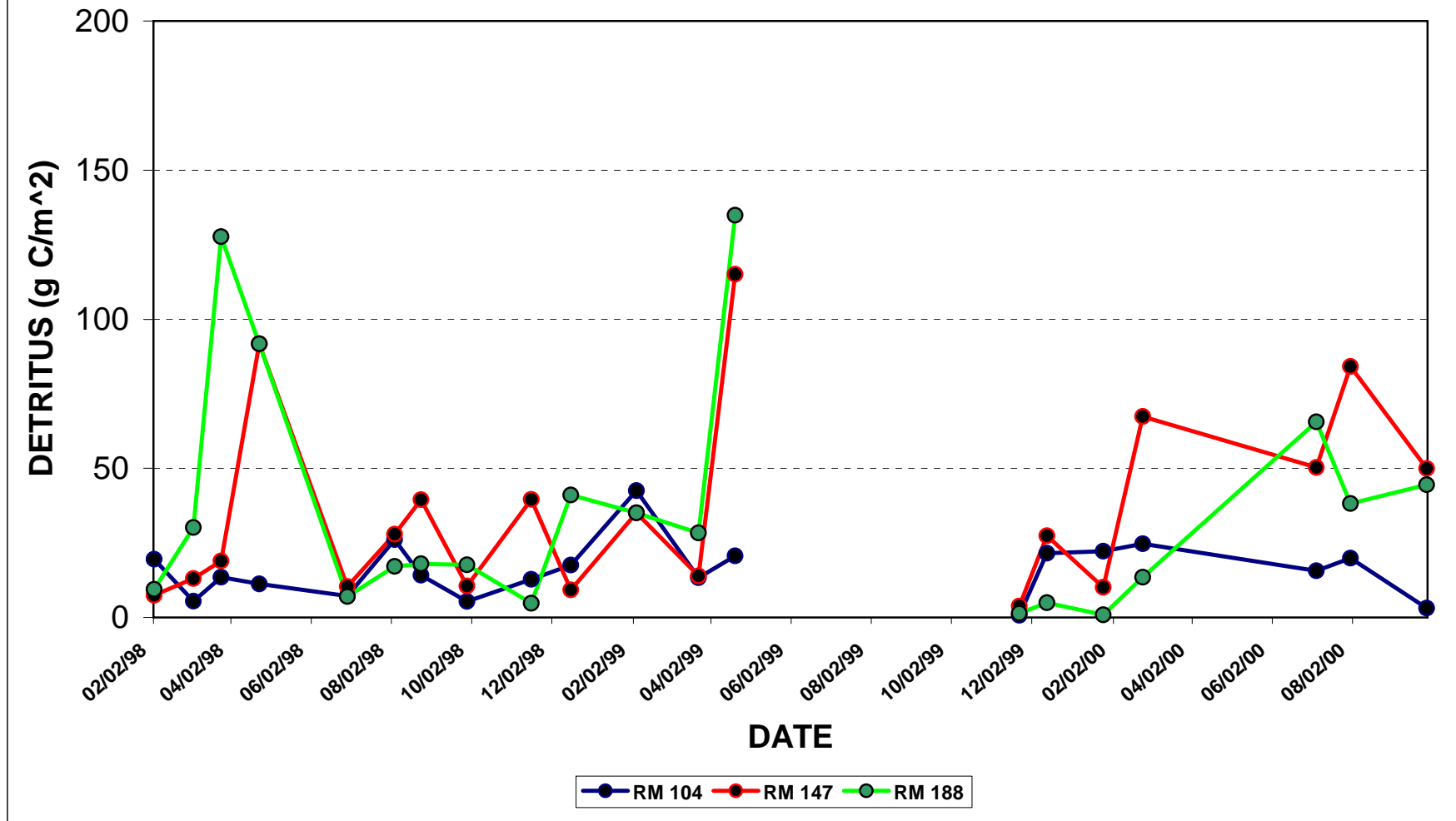

Figure 12. The temporal distribution of detritus biomass at three locations in San Juan River riffle habitat type.

SAN JUAN RIVER DETRITUS BIOMASS IN RUNS

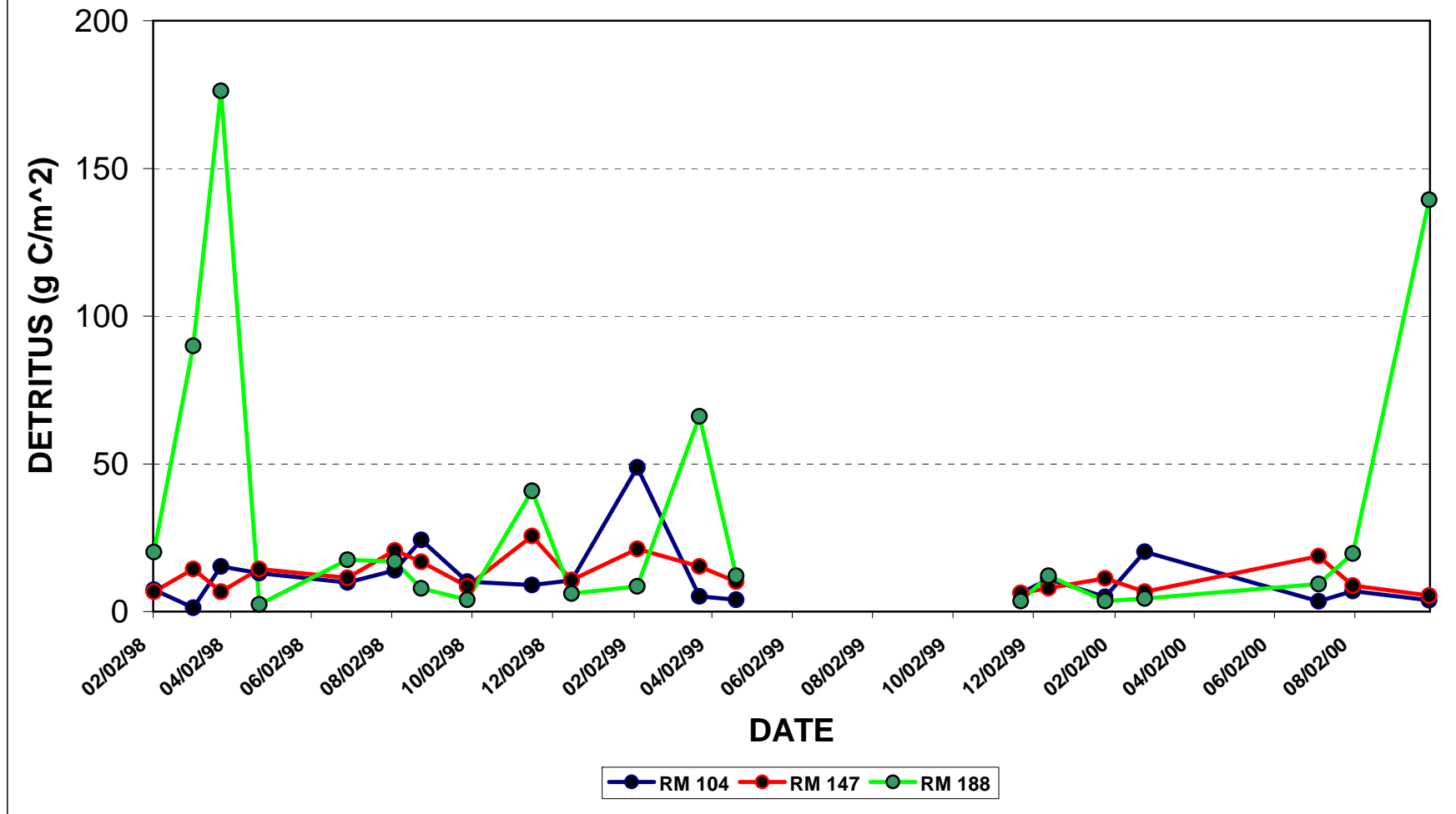

Figure 13. The temporal distribution of detritus biomass at three locations in San Juan River run habitat type

SAN JUAN RIVER DETRITUS BIOMASS COMPARISONS

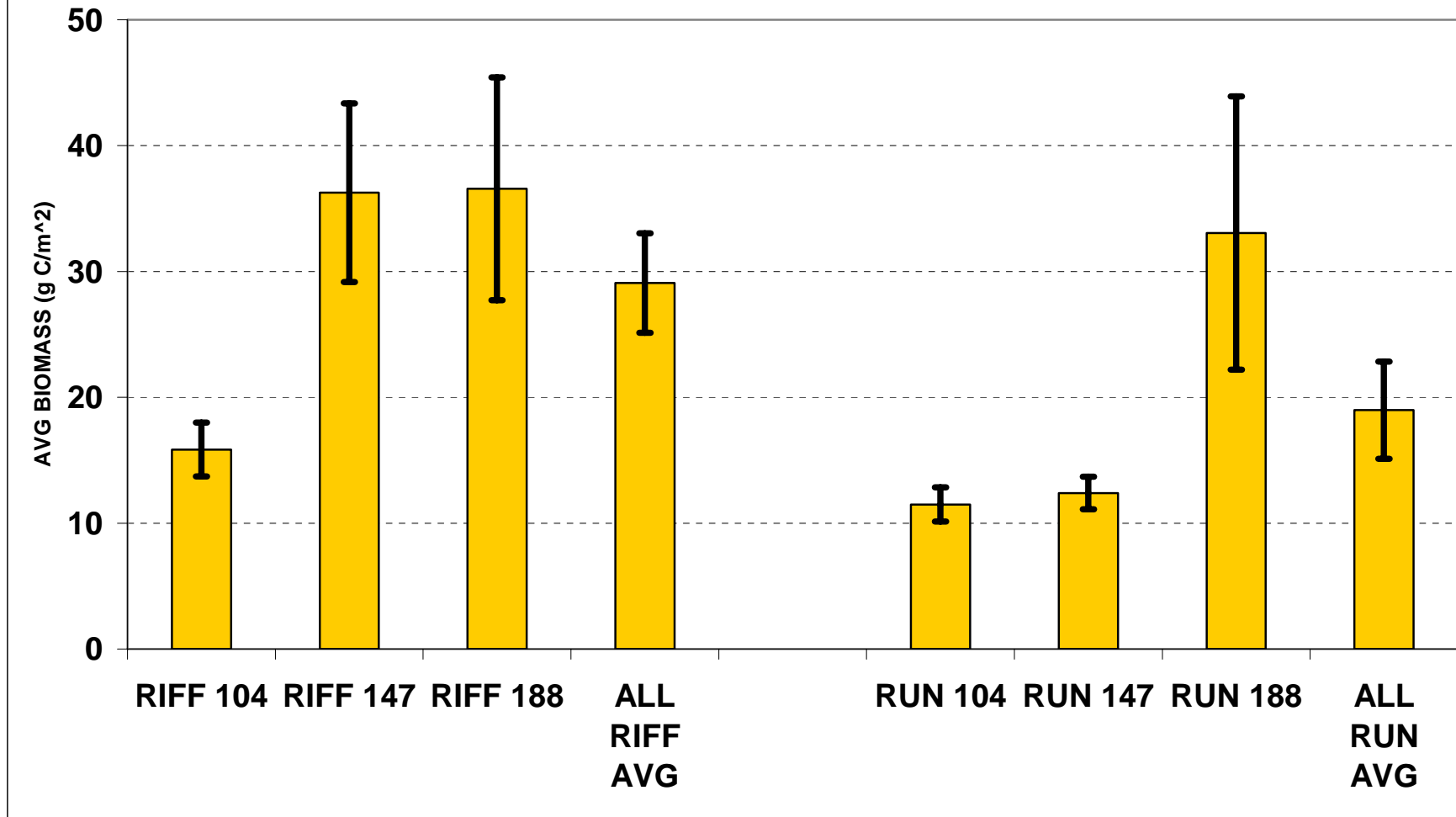

Figure 14. The comparison of the average detritus biomass for the study period (February 1998 to September 2000). Bars represent one standard error.

MACROINVERTEBRATES

The density and biomass of the macroinvertebrate community was determined at the same sites and times as the periphyton and detritus samples. At each sample point, triplicate samples were collected. Samples were sorted, identified and measured to the nearest millimeter. An example of the results of this analysis can be seen for *Hydropsyche sp* at RM 188 (Figures 15 and 16). The same data sets were collected for each major group of invertebrates at each site location (RM 188, RM 147 and RM 104).

Based on the results of the invertebrate data collections, the invertebrate community in the San Juan River had five major groups of invertebrates. These groups represented either a single species or several species within a genus. These groups were carried forward into the conceptual model and the bioenergetics modeling. As an overview of the data, the average biomass estimate for a group (expressed as mg C/m²) on a date and river mile are shown in Figures 17, 19 and 21, while Figures 18, 20, and 22 are summaries for the entire study period. The data shown indicate that in terms of biomass, the *Hydropsyche* group had the highest average overall biomass at each sample site. This Trichoptera represented the largest sized individuals in the invertebrate community and are univoltine in the San Juan River. The second largest group in the San Juan River was the Chironomidae group. This Diptera, which averaged 25% of the invertebrate biomass, was found to be multivoltine (3-5 generations/year). Simuliidae, which is also a Diptera, was the third most abundant group and also had multiple generations per year (2-3) in the San Juan River. The final two groups, Ephemerella and Baetis are both Ephemeroptera. Biomass estimates of Ephemerella were found to be consistently 5% of the community biomass. This species was univoltine in the San Juan River. The Baetis densities were the lowest of any group. This group was found to be multivoltine (2-3 generations/year) in the San Juan River.

In order to understand the functional value of the invertebrate community in terms of overall secondary production, production estimates were made using the age class data, individual size class weights, and the number of observed generations for each of the groups used in this study. Using the Hynes and Coleman (1968) method of secondary production (a modification of the removal-summation method), estimates of production (gm C/m²/year) were made at each sample location and each group. The data are presented in Table 5 and in Figures 23, 24 and 25. The results of these calculations indicate that the production within the stream community is well distributed among the five major groups with Chironomids having on average about 50% of the benthic production. Although this group did not have the highest biomass, they do have large numbers of generations per year thus resulting in a high turnover rate. This was also true with the Baetis group which had the lowest biomass (< 2% of the total biomass) but a proportionally higher per cent of the production (> 12% of the total production) due in part to multiple generations. In addition, it appears that the benthic invertebrate production decreases with distance downstream. The highest production was realized at RM 188 (4.11 gm C/M²/year) followed by RM 147 (2.18 gm C/m²/year) and RM 104 (1.64 gm C/m²/year). The reason for this decreasing secondary production is unknown.

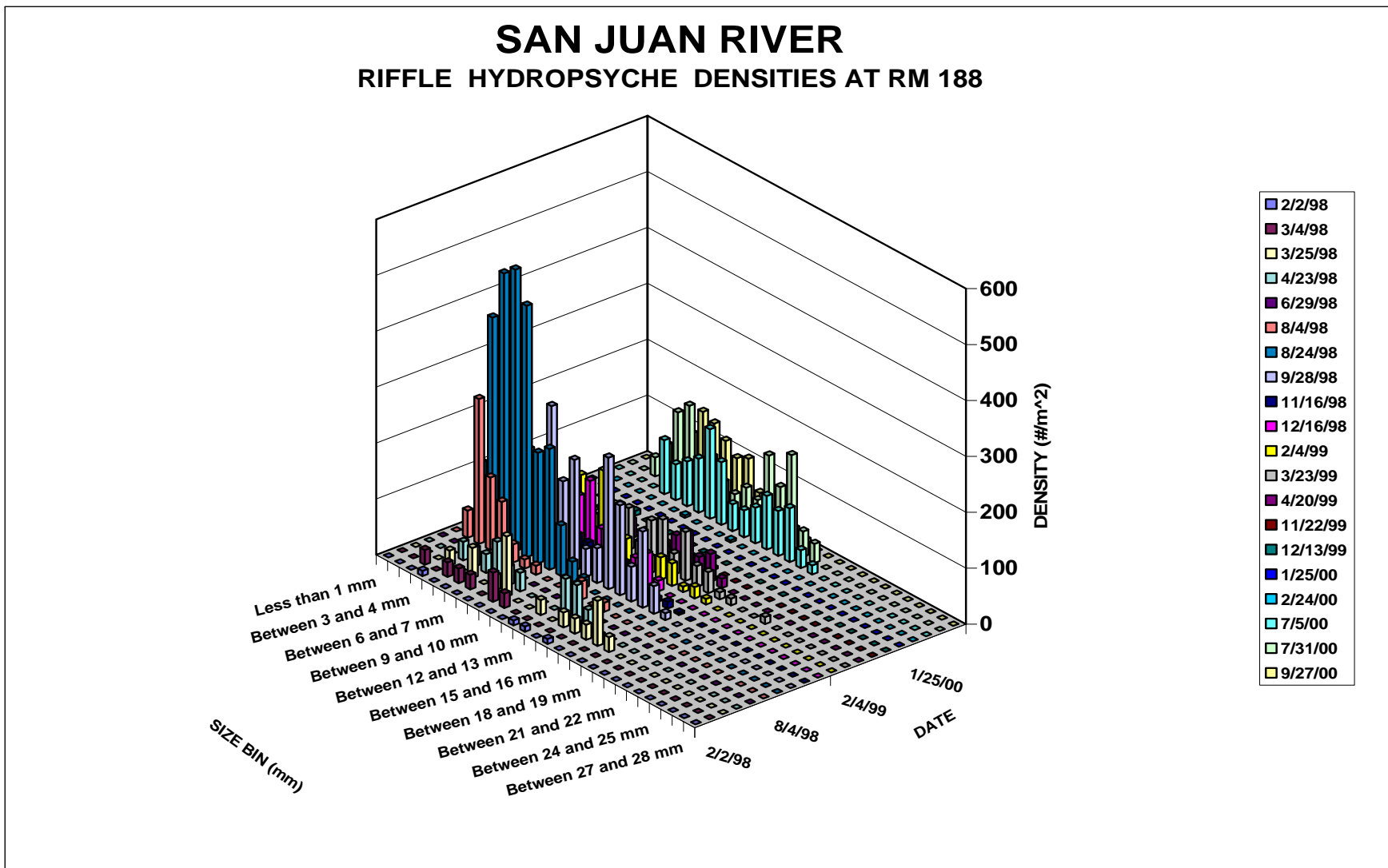

Figure 15. The density by size class of Hydropsyche in the San Juan River at RM 188 over 20 sample dates.

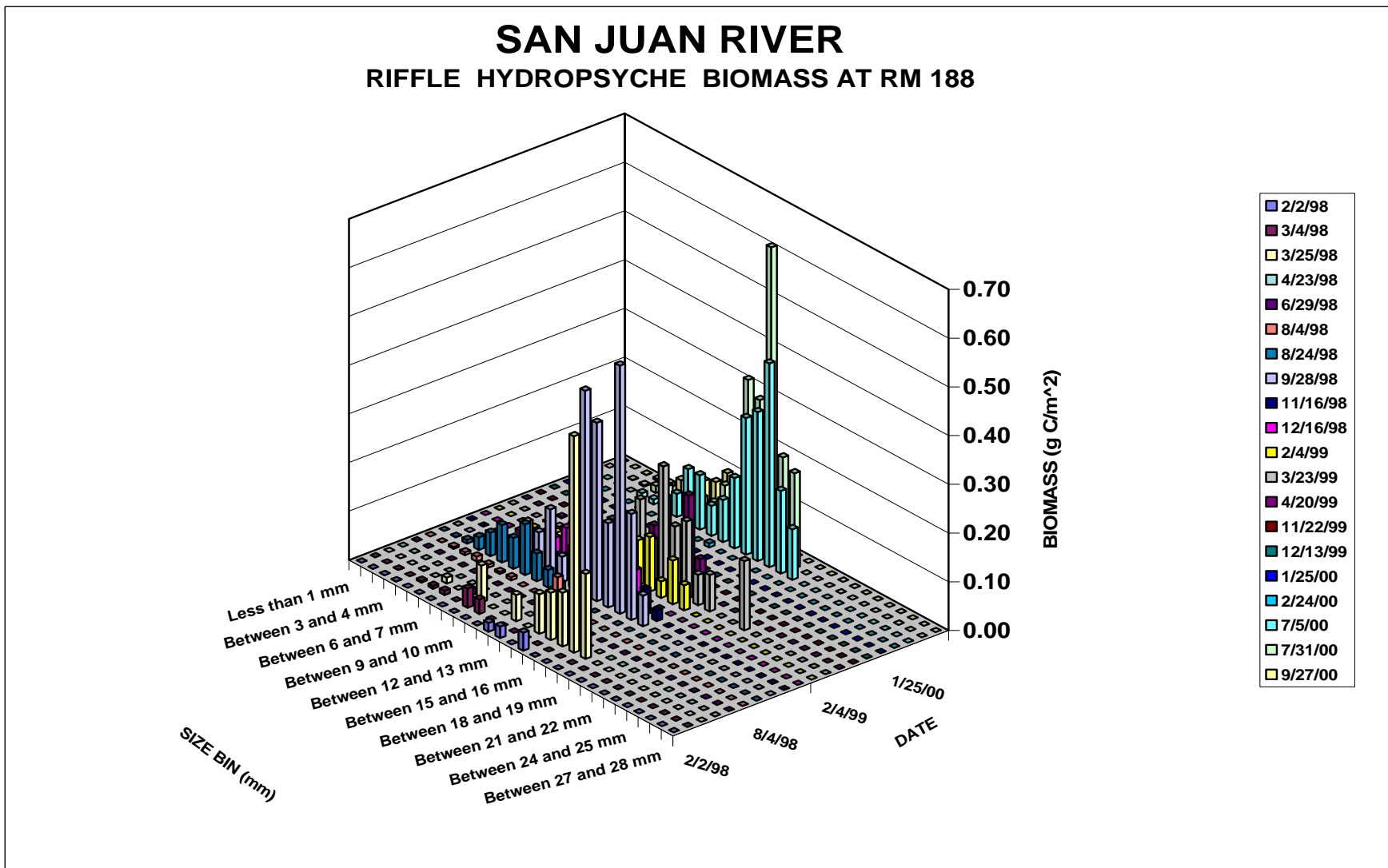

Figure 16. The biomass by size class of Hydropsyche in the San Juan River at RM 188 over 20 sample dates.

**SAN JUAN RIVER
MACRO INVERTEBRATE BIOMASS RM 104**

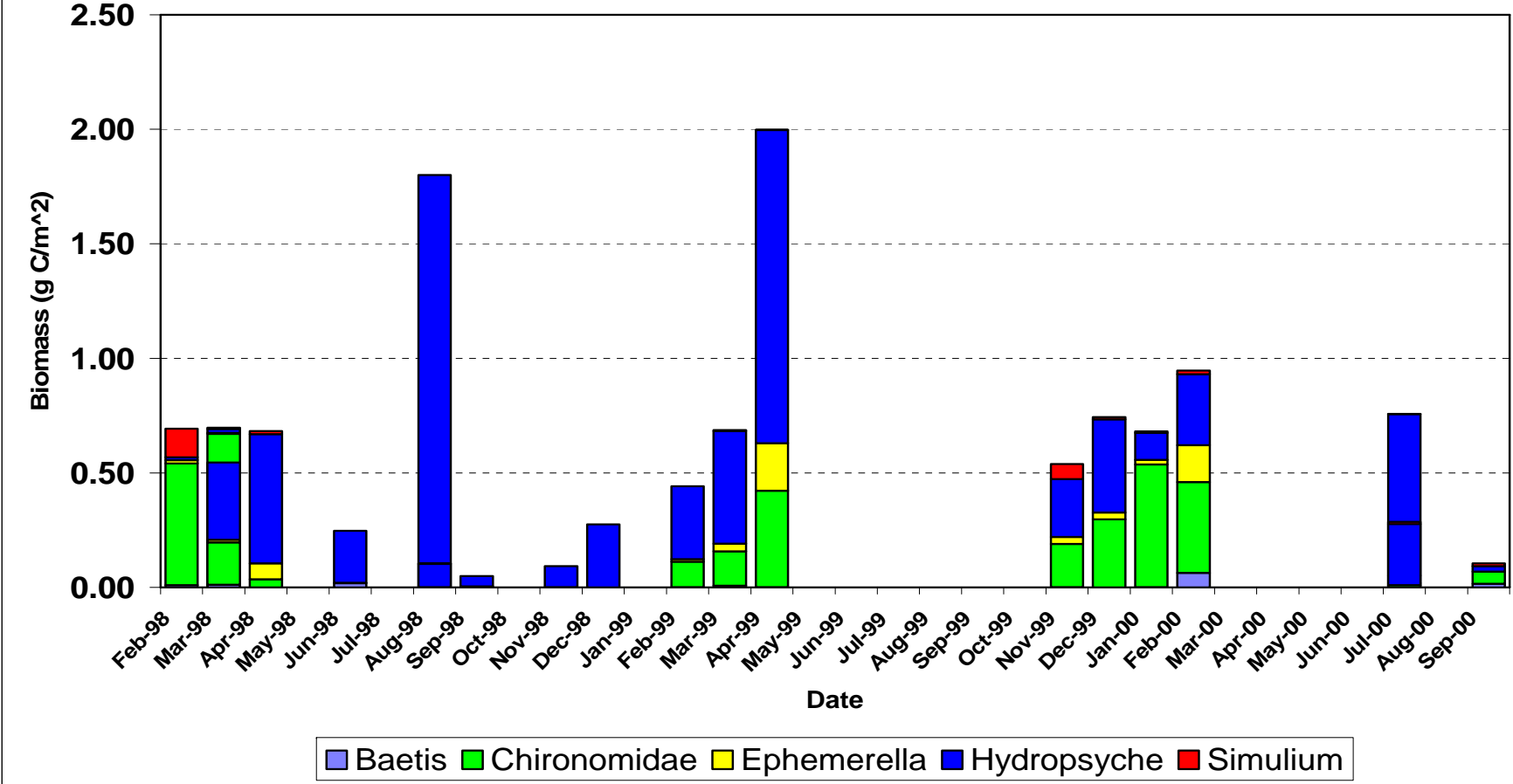

Figure 17. The biomass estimates of each major group of macroinvertebrates at RM 104 in the San Juan River.

SAN JUAN RIVER MACRO INVERTEBRATES RM 104

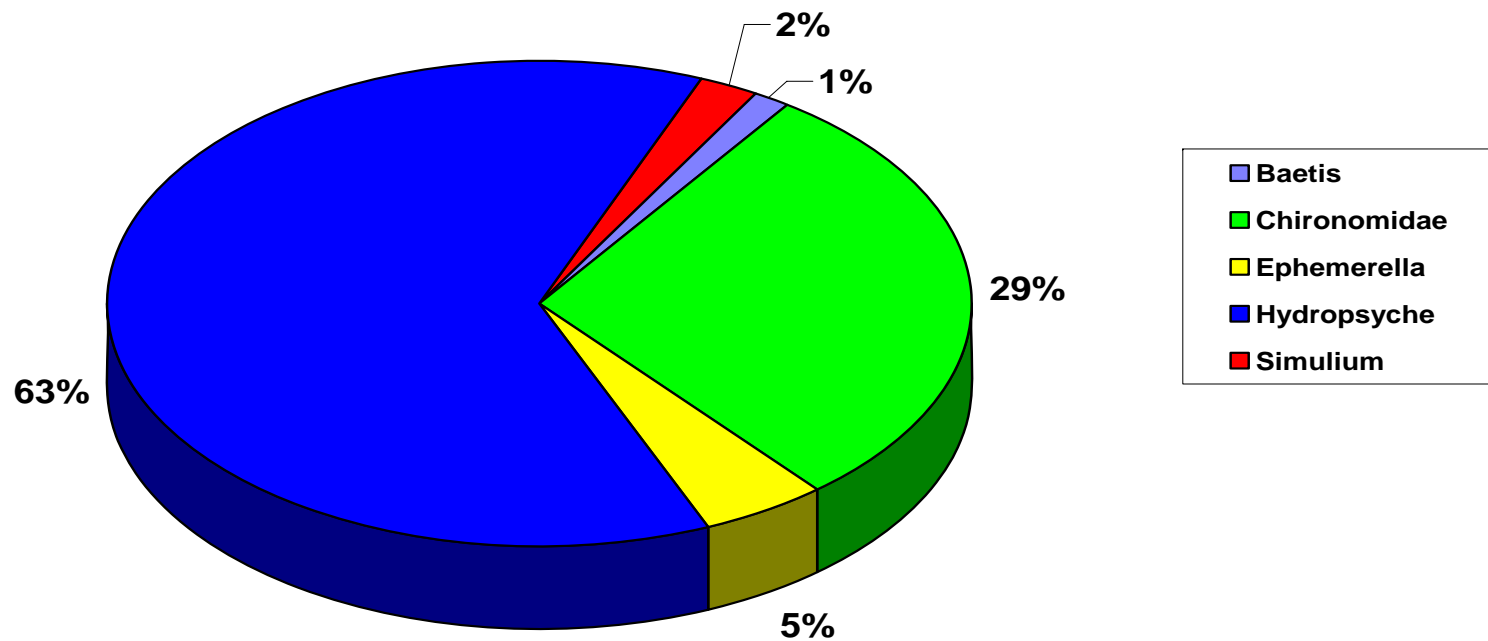

Figure 18. The average per cent distribution of the five major groups of invertebrates at RM 104 in the San Juan River between 2/1998 and 9/2000.

SAN JUAN RIVER MACRO INVERTEBRATE BIOMASS RM 147

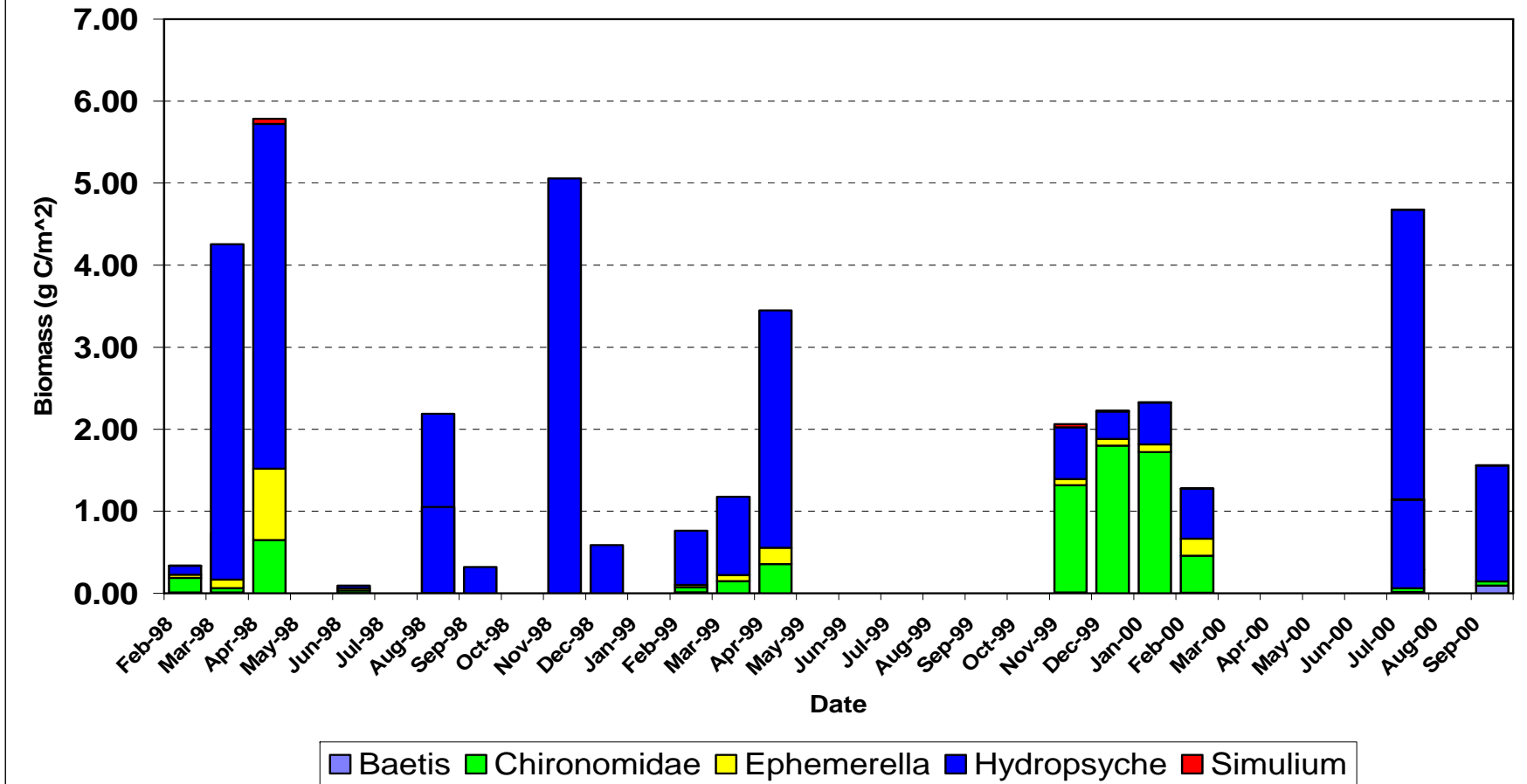

Figure 19. The biomass estimates of each major group of macroinvertebrates at RM 147 in the San Juan River.

SAN JUAN RIVER MACRO INVERTEBRATES RM 147

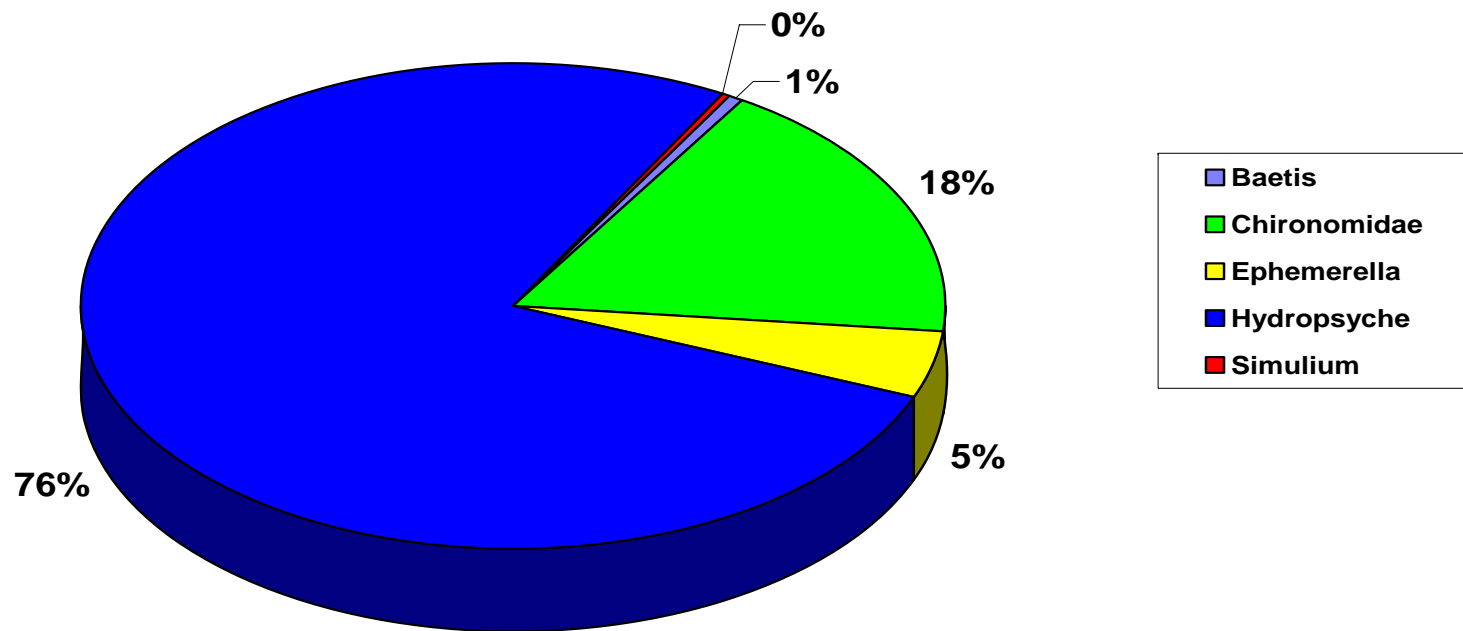

Figure 20. The average per cent distribution of the five major groups of invertebrates at RM 147 in the San Juan River between 2/1998 and 9/2000.

SAN JUAN RIVER MACRO INVERTEBRATE BIOMASS RM 188

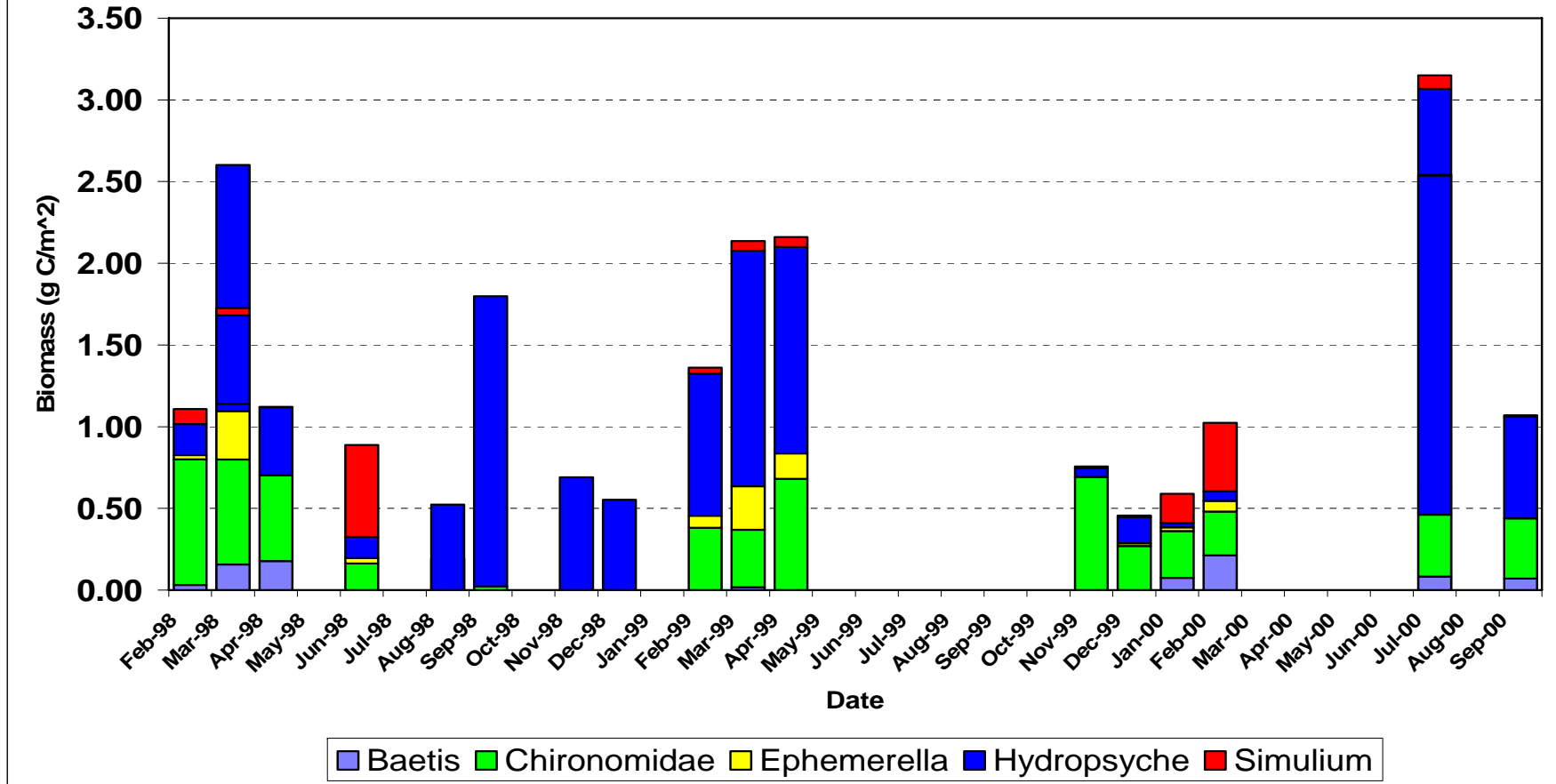

Figure 21. The biomass estimates of each major group of macroinvertebrates at RM 188 in the San Juan River.

SAN JUAN RIVER MACRO INVERTEBRATES RM 147

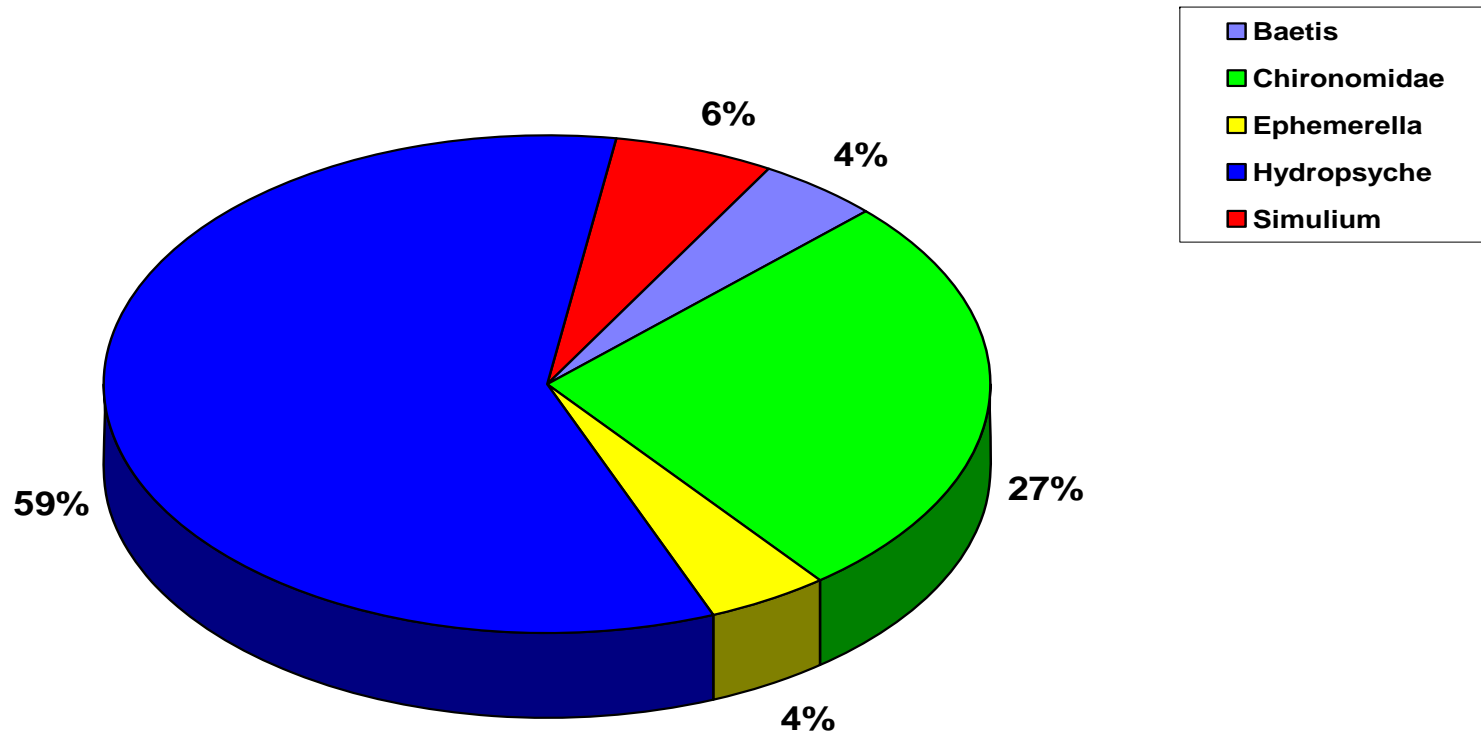

Figure 22. The average per cent distribution of the five major groups of invertebrates at RM 188 in the San Juan River between 2/1998 and 9/2000.

Table 5. A summary of the annual production estimates in the San Juan River for 1998-1999.

INVERTEBRATE GROUP	ANNUAL PRODUCTION (gms C/m ² /year)			
	RM 104	RM 147	RM 188	AVERAGE
Baetis	0.13	0.37	0.59	0.10
Chironomidae	0.86	1.17	1.91	1.20
Ephemerella	0.03	0.20	0.09	0.12
Hydropsyche	0.56	0.35	1.16	1.04
Simulium	0.07	0.08	0.36	0.53
TOTAL	1.64	2.18	4.11	2.99

SAN JUAN RIVER MACRO INVERTEBRATES PRODUCTION RM 104

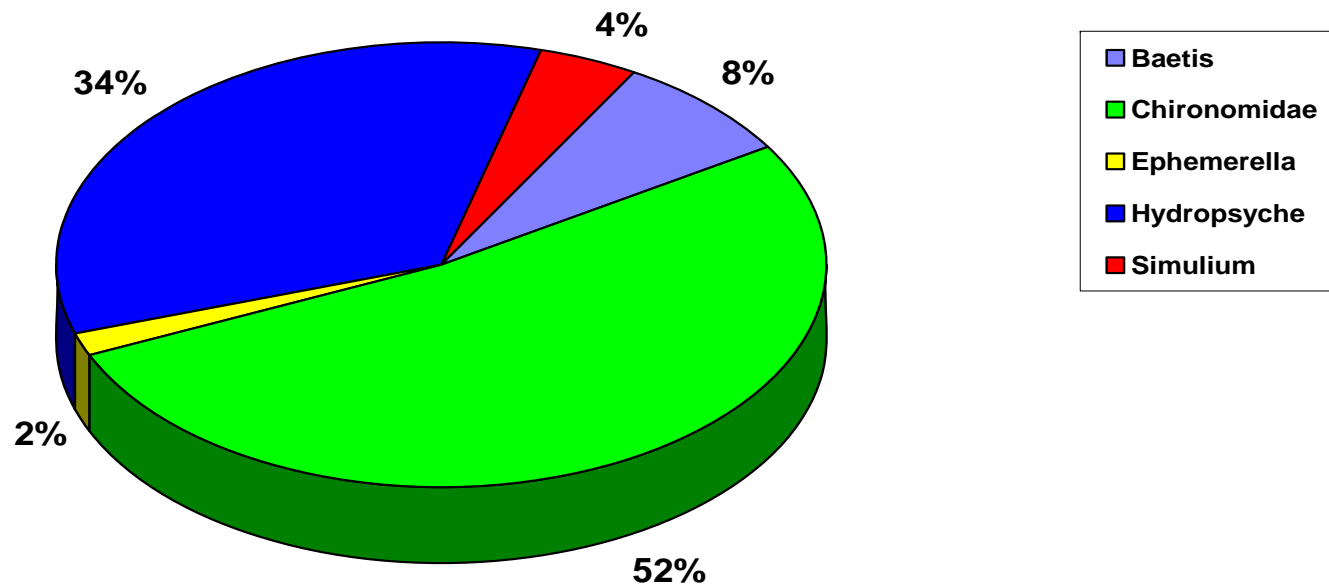

Figure 23. The per cent distribution of the annual production (1.64 gms C/m²/year) by invertebrate group at RM 104 in the San Juan River.

SAN JUAN RIVER MACRO INVERTEBRATES PRODUCTION RM 147

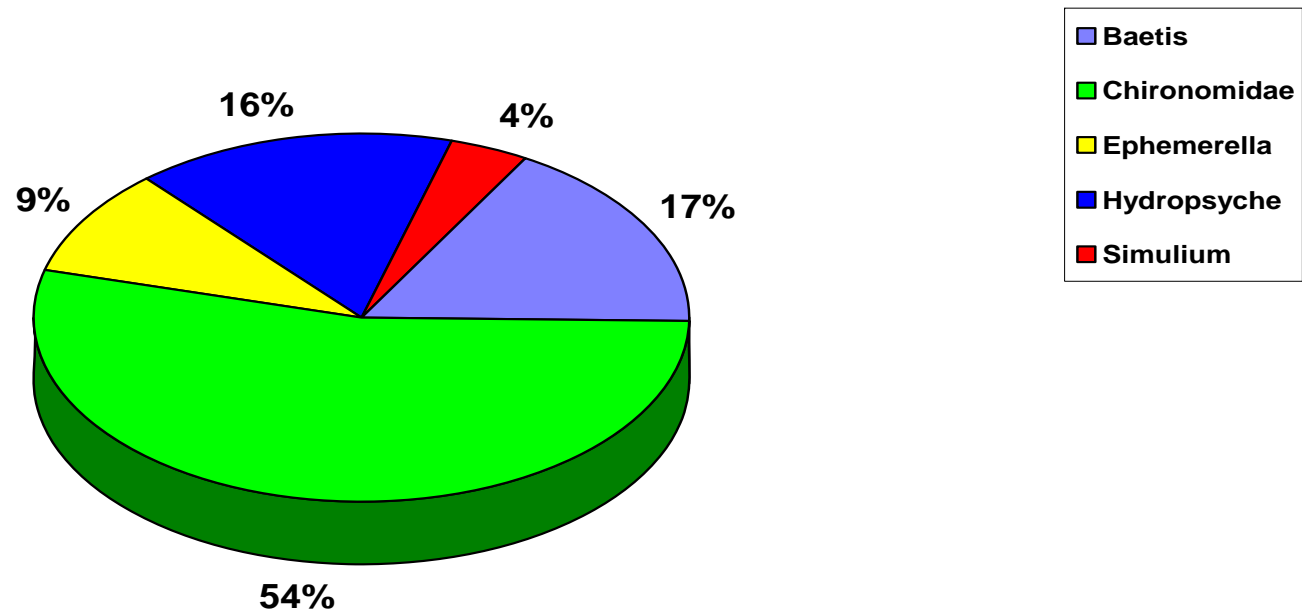

Figure 24. The per cent distribution of the annual production (2.18 gms C/m²/year) by invertebrate group at RM 146 in the San Juan River.

SAN JUAN RIVER MACRO INVERTEBRATES PRODUCTION RM 188

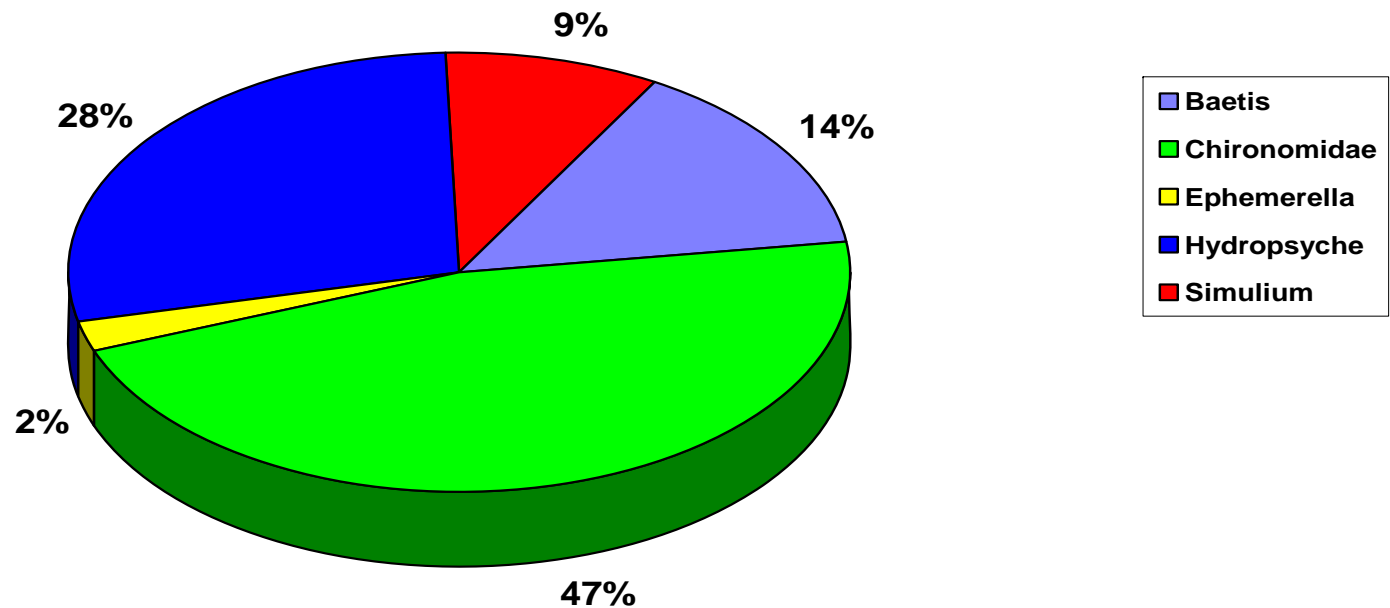

Figure 25. The per cent distribution of the annual production (4.11 gms C/m²/year) by invertebrate group at RM 188 in the San Juan River.

TROPHIC RELATIONSHIPS

In order to better define the trophic relationships within the San Juan River, this investigation collected ecosystem components and ran stable isotope analysis in order to quantify the concentration of ^{13}C and ^{15}N in terrestrial litter, benthic detritus, drift detritus, periphyton, invertebrates and fish in the San Juan River. Each component sampled was collected river wide and composited into replicate samples. The results of this analysis can be seen in Figure 26. The results of this preliminary study are similar to other investigations of stable isotope distributions in aquatic environments. For example, Peterson and Fry (1987) found terrestrial litter with a Carbon 13 signature of -28 ‰ and benthic algae -17 ‰. In this study we defined terrestrial litter from the four major riparian sources. The average was -27.65 ‰ with a range of -26.65 ‰ to -29.57 ‰ (Table 6). In a similar manner, we found periphyton values of -18.32 ‰. Inspection of the detritus component indicates that coarse particulate detritus was dominated by terrestrial litter fall (-23.38 ‰) while fine and ultrafine detritus had periphyton as its primary source (-19.19 and -17.15 ‰). The various size fractions of drifting detritus were intermediate in their carbon signature, however they tended towards the terrestrial litter. Within the secondary trophic level (benthic invertebrates) the Hydropsyches, which represented the collector/filter feeding functional group had carbon signatures closer to the allochthonous sources than autochthonous. On the other hand, the invertebrate members in the Baetis group (which represented the scrapers/collector feeding group) were closer in signature to the periphyton (autochthonous) source. It is interesting to note that the secondary consumers (fish species) and predators (vertebrate and invertebrate) had carbon signatures which tended toward the allochthonous source signatures (approximately -24 ‰). This would mean that the dominant energy sources for the San Juan River food chains tended towards terrestrial detritus. This is consistent with the periphyton biomass data and the primary production experiments which indicate that the San Juan River was a light limited system.

The use of ^{15}N as a measure of trophic position has indicated that the higher the ^{15}N signature ratio, the higher the trophic position (Zanden et al 1997). In this study we found good agreement with that analysis. Top predators, (in this case brown trout) had the highest ^{15}N signatures followed by speckled dace which exclusively eat invertebrates. The remaining fish (including suckers and channel catfish) were intermediate relative to the predator and invertebrates. The terrestrial primary producers (and litter) were the lowest ^{15}N signatures. It is interesting to note that the periphyton collected in the San Juan River had a high ^{15}N signature. This is consistent with the findings of Cabana and Rasmussen (1996) where they found higher ^{15}N signatures with increasing population densities. For the San Juan River, we hypothesize that the major sources of nitrogen to the aquatic environment are the result of anthropogenic activities. In summary, the stable isotope analysis has shown that the dominant carbon source (and thus energy) appears to be the terrestrial riparian community. In addition, the major fish species in the system occupy intermediate trophic positions and derive their energy from invertebrates, periphyton and detritus.

SAN JUAN RIVER STABLE ISOTOPE ANALYSIS

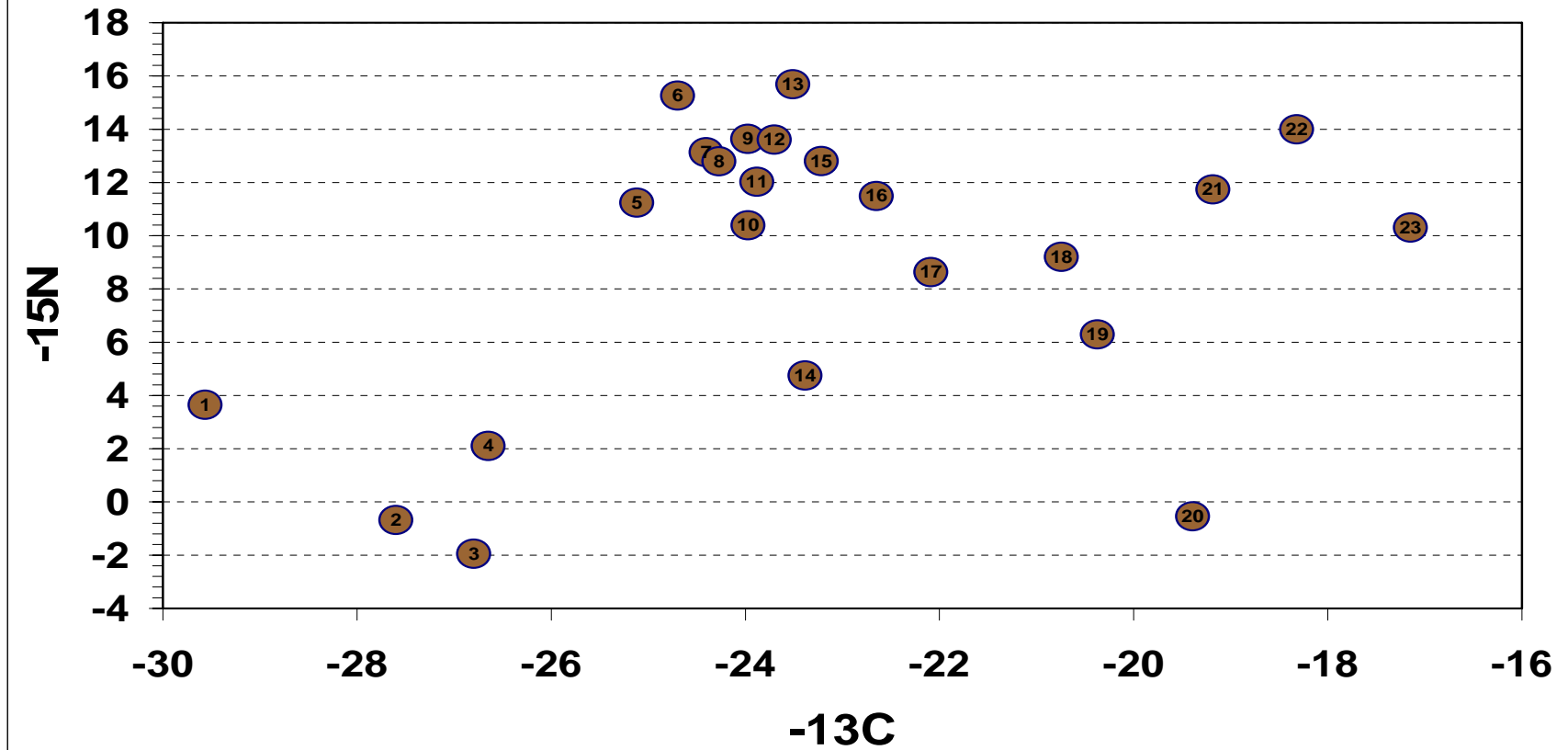

Figure 26. The distribution of ecosystem components in the San Juan River relative to nitrogen and carbon stable isotopes

Table 6. The results of the stable isotope analysis conducted on ecosystem components in the San Juan River

ID Number	Species/Functional group	del 13C	del 15N
1	Willow	-29.566	3.648
2	Cottonwood	-27.601	-0.676
3	Russian olive	-26.799	-1.942
4	Tamarisk	-26.649	2.105
5	Fathead minnow	-25.118	11.241
6	Speckled dace	-24.698	15.260
7	Red shiner	-24.403	13.140
8	Rrazorback sucker	-24.272	12.789
9	Bbluehead sucker	-23.974	13.632
10	Hydropsyche/collector-filterers	-23.972	10.394
11	Perlodids/predators	-23.880	12.029
12	Flannelmouth sucker	-23.703	13.606
13	Brown trout	-23.510	15.692
14	Benthic CPOM	-23.383	4.752
15	Channel catfish	-23.217	12.804
16	Baetis/collector-scrapers	-22.651	11.488
17	Aquatic CPOM drift	-22.089	8.632
18	Aquatic UFPO drift	-20.745	9.203
19	Aquatic FPOM drift	-20.374	6.292
20	Terresterial grass	-19.394	-0.540
21	Benthic fine detritus	-19.183	11.743
22	Periphyton	-18.322	14.000
23	Benthic ultrafine detritus	-17.148	10.308

PIKEMINNOW BIOENERGETICS ESTIMATES

Following the development of the initial conceptual model of the San Juan River, an independent estimate of the carrying capacity of the pikeminnow in the San Juan River was undertaken. The purpose of this initial work was to evaluate the amount of species specific data available for the bioenergetics analysis, and to determine the level of resolution necessary for model construction. The results of that analysis are as follows.

Evaluation of the bioenergetics for Colorado pikeminnow used available data from other piscivorous species similar in body type and habitat use to Colorado pikeminnow. Several data sets were necessary in order to determine the consumption rates of this predator. First, Colorado pikeminnow population characteristics were needed. Estimated length/weight regressions for Colorado pikeminnow were derived from Vanicek (1967) with actual observation of San Juan River pikeminnow used as confirmation that this relationship held for the San Juan River (Figure 27). Age structure for the population shown in Figure 28 was developed by using the criteria for delisting proposed by Valdez and Ryel (2000) and a total adult population of 2,200 fish. The maximum life span used for Colorado pikeminnow was 35 years. To calculate the biomass for an individual pikeminnow by age or size we utilized the length and age /weight relationship developed by Vanicek (1967) as shown in Figure 27. Total Colorado pikeminnow biomass distributed by age is shown in Figure 29 for the same distribution of the 2,200 adult pikeminnow.

The second data set needed was physiological characteristics relative to fish bioenergetics. The computer program Fish Bioenergetics v.3.0 (Hansen et al. 1977) was used for bioenergetic simulations. This model will hereafter be referred to as the "Wisconsin Model". This model uses predictive equations for estimating grams of prey consumed based upon body weight (grams) of the consumer and the associated growth increments (grams). The input parameters for the consumption, respiration, and egestion/excretion functions from muskellunge (Bevelhimer et al. 1985) were selected to represent Colorado pikeminnow functions. The muskellunge was selected as a surrogate species based upon similar body morphologies, feeding characteristics, and temperature preferences. A summary of the parameters used for the Colorado pikeminnow bioenergetic simulations are located in Table 7. Two predator energy densities, northern pikeminnow and individual species default, were evaluated for a wide range of piscivorous species to determine what effect a higher energy density would have on consumption rates (Sources for predator parameters are located in Table 8). Results for the simulations using the northern pikeminnow and species default predator energy densities are presented in Figure 30. The predator energy density of northern pikeminnow (6703 j/g) was selected for use. The Colorado pikeminnow consumption rate is approximately in the middle of the range exhibited by the piscivores simulated. The Wisconsin Model simulates the loss of body mass and the additional consumption required to reach the end weight inputted by removing a user defined percent of body mass from the predator on the day of spawning (only one day may be used). All individuals seven years or older were assumed to have spawned. Another input for the model is water temperature. The average daily water temperature data used in all

Predicted and observed weights (g) for Colorado pikeminnow captured in the San Juan River
1987-1997

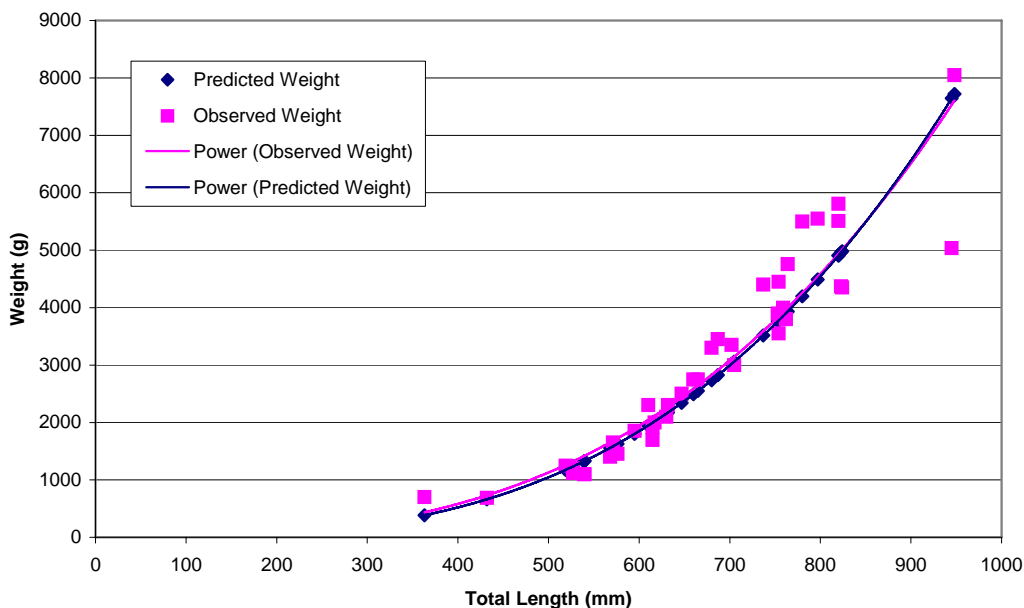

Figure 27. Predicted and observed weights (g) of Colorado pikeminnow captured in the San Juan River from 1987-1997.

Theoretical Colorado pikeminnow age class distribution

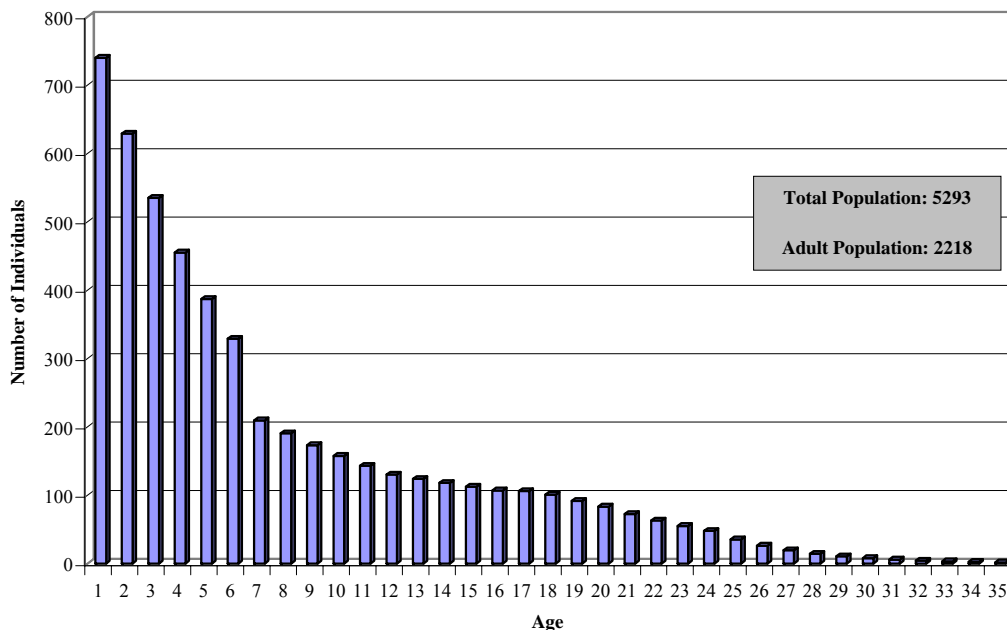

Figure 28. Theoretical Colorado pikeminnow age class distribution.

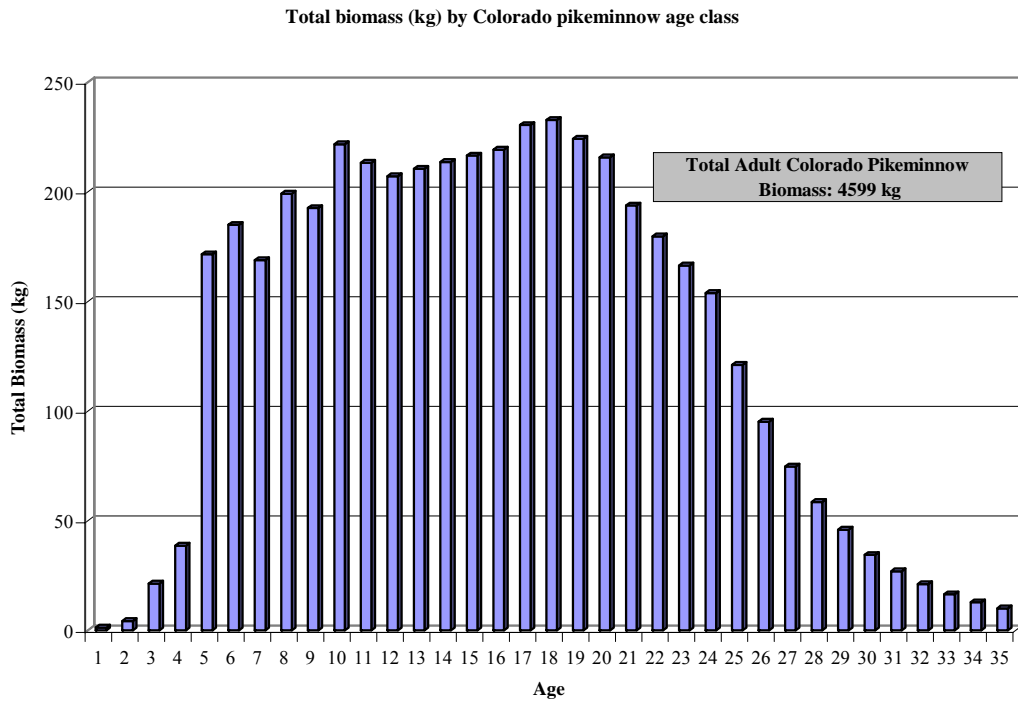

Figure 29. Total biomass (kg) of each Colorado pikeminnow age class.

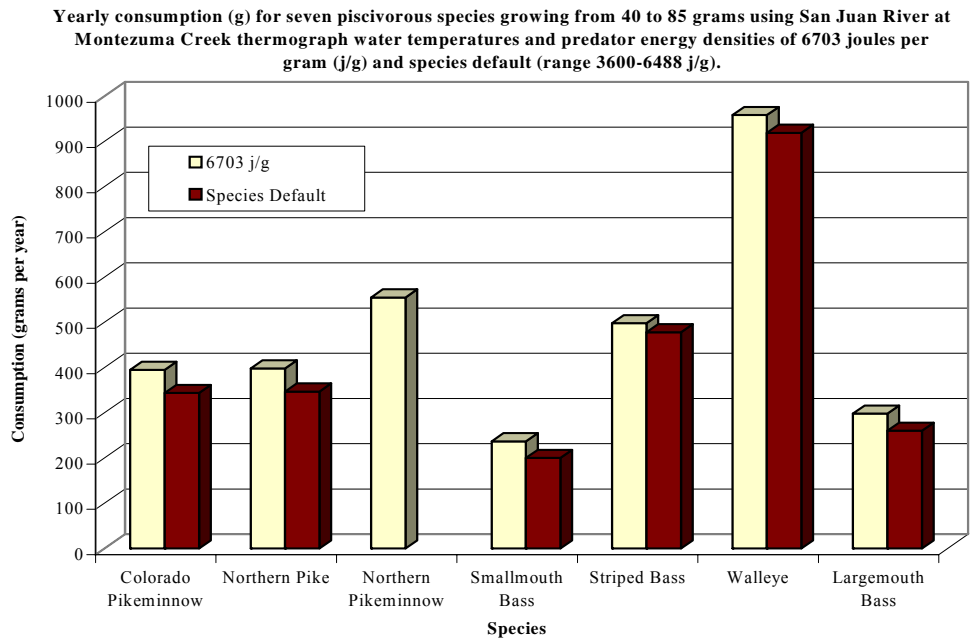

Figure 30. Yearly consumption rate (g) for seven piscivorous species using the Wisconsin model to simulate the consumption requirements.

Table 7. Parameters used for Colorado pikeminnow bioenergetic simulations.

Parameter	Value	Species	Source
Consumption			
Mass dependence function intercept	0.2215		
Coefficient of mass dependence	-0.18		
CQ: Approximates a Q ₁₀	2.53		
Optimum temperature	26°C		
Maximum water temperature	34°C		
Respiration			
Specific weight of O ₂ consumed by a 1g fish at 0°C	0.00246	Muskellunge	Bevelhimer et al. 1985
Standard metabolism function slope	-0.18		
RQ: Approximates a Q ₁₀	0.055		
Swimming speed velocity	0.1222 cm/s		
Specific dynamic action	0.14		
Egestion/Excretion			
Egestion	0.2		
Excretion	0.07		
Energy Density			
Colorado pikeminnow	6703 j/g	Northern Pikeminnow	Petersen and Ward 1999
Prey	4500 j/g		
Spawning			
Percent of body weight lost	4.1%	Northern Pikeminnow	Petersen and Ward 1999
Day of spawning	1 July		Bestgen et al. 1998, Miller and Ptacek 2000
Water Temperature			
Montezuma Creek thermograph	daily		SJR Integrated Database v.2.0
Farmington thermograph	daily		SJR Integrated Database v.2.0

Table 8. Sources for parameters used in bioenergetic simulations for six predatory fish species.

Species	Source
Northern Pikeminnow Parameters	Petersen and Ward 1999
Northern Pike Default Parameters	Bevelhimer et al. 1985
Largemouth Bass Default Parameters	Rice et al. 1983
Smallmouth Bass Default Parameters	Shuter and Post 1990
Striped Bass Default Parameters	Hartman and Brandt 1995
Muskellunge Default Parameters	Bevelhimer et al. 1985

bioenergetic simulations was obtained from the San Juan River Integrated database. The Montezuma Creek and Farmington thermograph sites were selected to generally represent upper and lower river reaches, respectively.

The final data set needed was an estimate of the biomass of available prey. These biomass estimates for forage fish and nonnative species came from removal estimates conducted in 1998 and 1999, as previously noted. Riffle, shoreline run, and boat electrofishing data was used to determine species biomass by size class for each mile censused. Total biomass was divided into forage species that were susceptible to predation by Colorado pikeminnow < 650 mm in length and Colorado pikeminnow > 650 mm length. For the Colorado pikeminnow > 650 mm in length, prey size was limited to 410 mm and less. Prey biomass was limited to 300 mm and less for Colorado pikeminnow <650 mm.

Utilizing all three data sets it was possible to estimate the annual consumption rate of Colorado pikeminnow based on the weight for each age, the growth in biomass between age class, and age structure as estimated from Valdez and Ryel (2000). The calculated yearly consumption requirements of this hypothetical pikeminnow population and the available prey biomass are discussed below.

Valdez and Ryel (2000) provide a summary of recovery goals for the Colorado pikeminnow in the upper, lower and San Juan River basins. Their basis for the population numbers for all of these areas is genetic and demographic viability. The preliminary recovery goal for the San Juan River is approximately 2,200 adults. This population number of reproducing adults would require additional subadults, juveniles and young-of-the-year each year to maintain this number annually in the San Juan River. The breakdown of the age structure based on criteria presented by Valdez and Ryel (2000) is shown in Figure 28. The total number of Colorado pikeminnow required to maintain the age structure of adults and the proportion of subadults and juveniles is approximately 5,300 individual fish. Total Colorado pikeminnow biomass is estimated at approximately 4600 kg (Figure 29).

The bioenergetic dynamics or impacts of the Colorado pikeminnow upon its prey base presented here is an initial evaluation of the proposed population densities numbers suggested by Valdez and Ryel (2000) for the San Juan River. This impact analysis does not include the biomass estimates for channel catfish and common carp, both of which are not considered prey species for Colorado pikeminnow. Channel catfish are known to cause mortalities to Colorado pikeminnow and is likely not a preferred food item. In addition, common carp rapidly reach a body shape and size that exceeds the gape of Colorado pikeminnow for forage. Both of these species, catfish and carp, consume resources that, if they were absent from the system, would be available to the lower trophic levels in the San Juan River. The exclusion of these trophic dynamics by shunting resources to unavailable prey (nonnatives) reduces the biomass of forage species for Colorado pikeminnow. The total biomass in Reach 3 near Bluff is approximately 1200 kg for all species, including catfish and carp (Figure 31). Nonnative catfish and carp comprise nearly 80 % of the biomass.

The composition and density (Figure 32 and 33) of the prey community has been quantitatively determined from 1998 to 2001. The age class that made up susceptible prey in the San Juan River in 1998 was predominantly of age 1 and older native suckers (Figure 32 and 33). Small fishes such as speckled dace, red shiner, and fathead minnow all make up a very small proportion of the prey biomass. The largest proportion of those small fishes is seen in reach 6 with a high number of speckled dace, which constitute approximately 11% of the prey biomass for Colorado pikeminnow <650 (Figure 32 and 33). The estimates show that in reach 3, the consumption needed for Colorado pikeminnow is higher than the prey biomass available for pikeminnow < 650 mm (Figure 32). Total prey biomass compared to total consumption for all pikeminnow is higher than the consumption needed. However, the consumption needed annually is a large proportion of the available prey, requiring approximately 80% of the biomass (Figure 33).

In reach 6, the prey biomass is approximately 60 percent higher than the required annual consumption to support the age structure of Colorado pikeminnow (Figure 33). The required consumption rate to support the number of pikeminnow per mile is approximately 40% of the total biomass and again the prey biomass is predominantly older age native suckers. Given that these older suckers maybe 10-12 years old, their replacement through recruitment would not be rapid.

Implications for the consumption to prey ratios from this initial analysis indicated that the prey biomass that is currently in the San Juan River is not high enough to sustain the numbers of pikeminnow predicted to be required for recovery by Valdez and Ryel (2000). There are several approaches to evaluating the proposed densities. One approach is to compare the biomass of each trophic level compared to the next upper level. In using this approach, the predator biomass should be approximately 10% of its prey base (Lindeman 1942; Mann 1965). We have previously noted that the biomass of the pikeminnow was calculated to be 4,600 kg. As noted above and shown in Table 3, the predator biomass ranges from 39% to 137% of the prey biomass. Another approach is to use the Trophic Utilization Efficiency (ratio of biomass consumed by predator to the

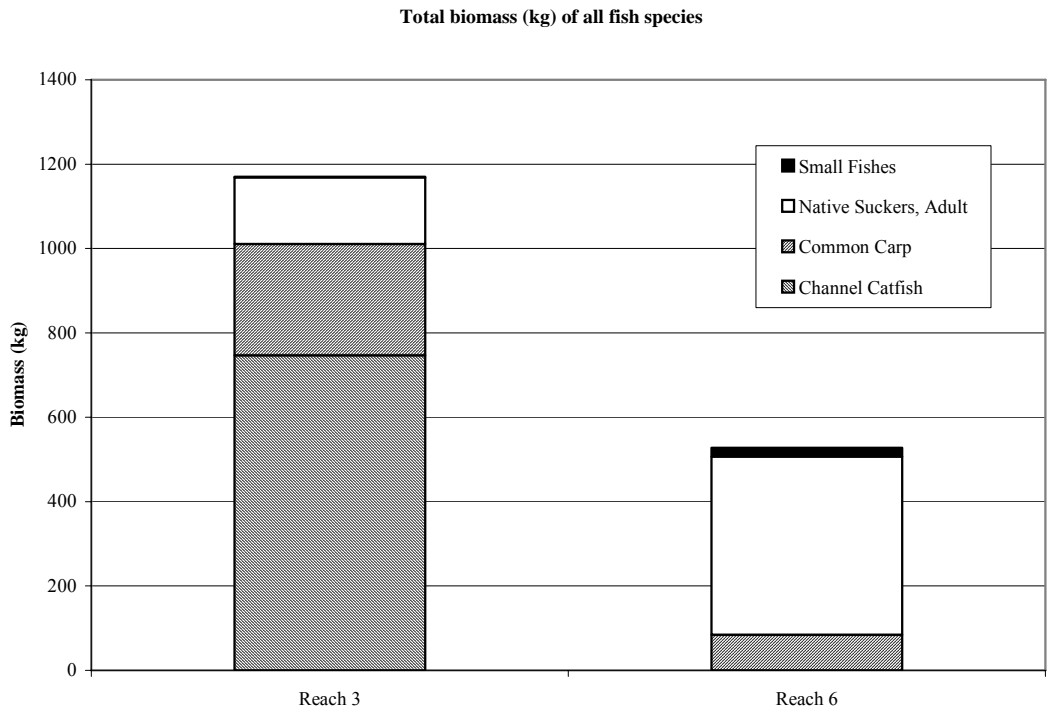

Figure 31. Total biomass (kg) for reaches 3 and 6 of the San Juan River.

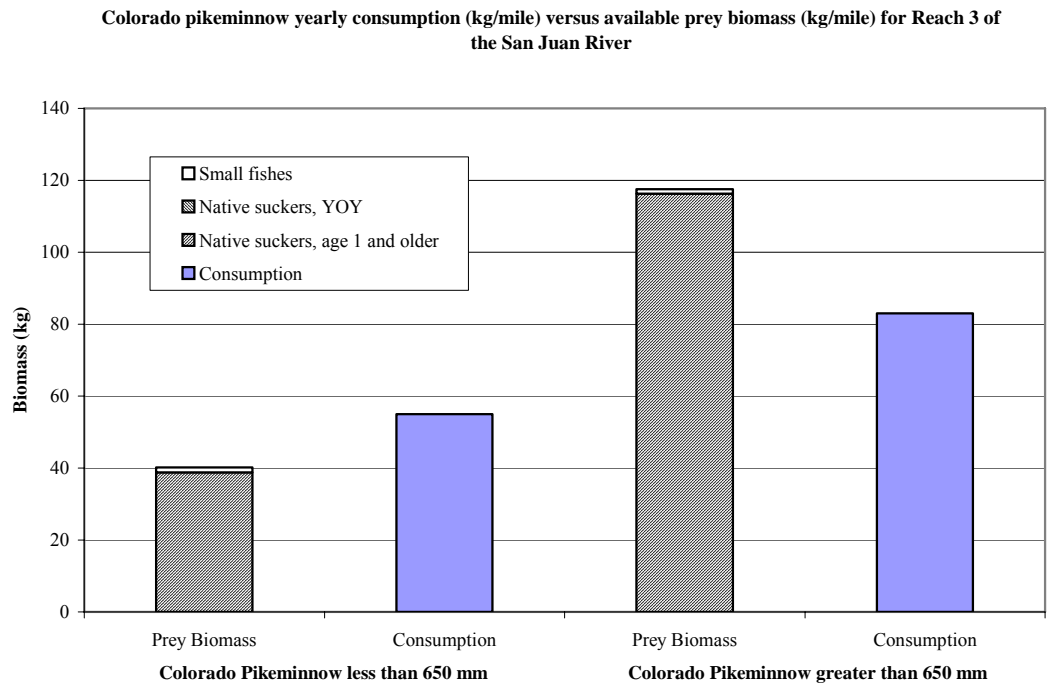

Figure 32. Colorado pikeminnow yearly consumption (kg/mile/year) and available prey biomass (kg/mile) for Reach 3 of the San Juan River.

Colorado pikeminnow yearly consumption (kg/mile) versus available prey biomass (kg/mile) for Reach 6 of the San Juan River

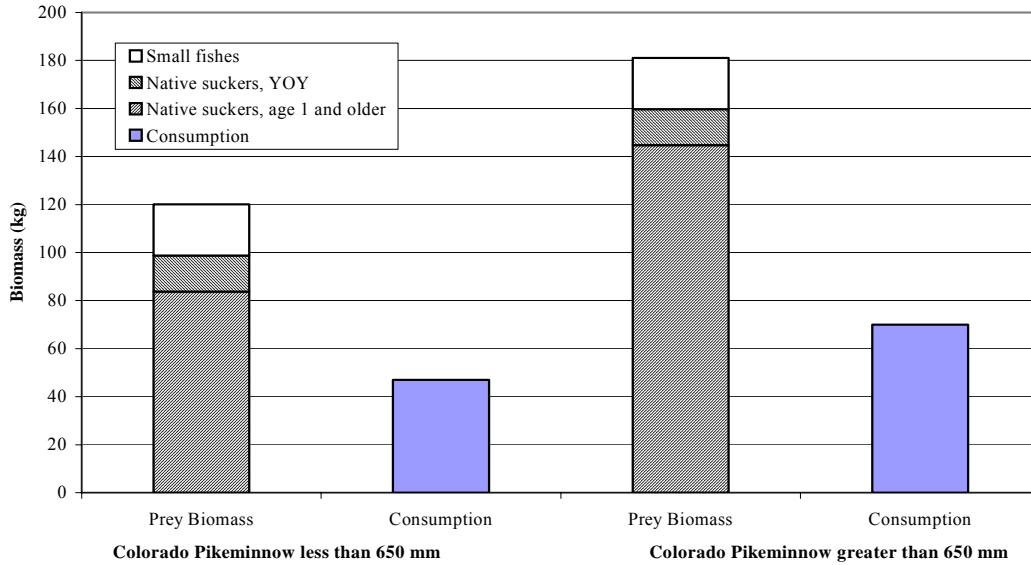

Figure 33. Colorado pikeminnow yearly consumption (kg/mile/year) and available prey biomass (kg/mile) for Reach 6 of the San Juan River.

biomass production of the prey. We have estimated the pikeminnow consumption biomass using the Wisconsin Model (Table 9).

Table 9. Estimates of available prey, and consumption of prey in the San Juan River.

Colorado Pikeminnow Size Class	Reach	Available Prey Biomass (kg/mile)	Consumed Prey Biomass (kg/mile/year)	Percent biomass Consumed (annual)
less than 650 mm	3	40	55	137%
greater than 650 mm	3	118	83	71%
less than 650 mm	6	120	47	39%
greater than 650 mm	6	181	70	39%

The annual production (kg/mile/year) can be estimated by the formula

$$P=R*(avg B)$$

where P is biomass production, R is turnover rate, and B is the biomass. For the San Juan River, our biomass estimates were made in September and probably represent an average annual weight for those aged fish. The turnover ratio will vary by species and fish size, with a range in the literature of 0.35 to 3.5. If we use an average of .65 for the San Juan River, our annual production for prey fish is shown in Table 10. The estimated range is 211% to 60% utilization. Literature values for food utilization efficiencies range between 25-35%.

Table 10. The estimate of the annual production of prey fish in the San Juan River assuming a Annual Turnover Ratio of 0.65.

Colorado Pikeminnow Size Class	Reach	Consumed Prey (kg/mile/year)	Annual Prey Production (kg/mile/year)	Utilization Efficiency
less than 650 mm	3	55	26	211%
greater than 650 mm	3	83	77	108%
less than 650 mm	6	47	78	60%
greater than 650 mm	6	70	118	59%

Other studies have shown that the daily prey consumption is approximately 3% of predator body weight (Whitledge and Hayward 1997). Bevelhimer et al. (1985) reported that northern pike daily consumption rates ranged from approximately 1% to 15% of body weight depending on water temperature. Lower daily rations were required at 5°C, whereas, the highest daily consumption rate was required at 25°C. Other studies report similar consumption rates for large predatory species (Carline 1987, Wahl and Stein 1991).

This would mean that the total biomass for any size structure for recovery would need a prey base that can support the needed consumption rates without a reduction in total prey biomass. The annual consumption, theoretically, should be from a stock that is replenished annually (its production) and does not reduce the ability for the prey species to reproduce and maintain population levels at a level high enough to sustain the consumption rates from the predators. When consumption of a prey species reduces the species to a point where it cannot fully replenish the consumed biomass in subsequent years, a downward trend would be realized. At some point the prey population will be reduced to a point where changes in the predator population will occur. An example of this may be Lake Michigan where studies have been conducted on the predator/prey dynamics of the pelagic fisheries. Brandt et al. (1991) used acoustic techniques to

determine prey abundance and bioenergetic modeling to determine total prey production as well as salmon consumption. They report that approximately 53% of the available prey production was consumed by the stocked salmon population. During 1981-83 the major salmon prey species (alewife) suffered a marked decline in population size. Stewart and Ibarra (1991) report that after the alewife decline, salmon populations demonstrated increased mortality and a 25% reduction in average weight. The authors also suggest that the alewife population has also lost the ability to quickly rebound after a sharp decline.

The initial pikeminnow bioenergetics modeling indicated that the current prey base (native fish and small nonnatives other than catfish and carp) in the San Juan River would not be able to sustain or to support a Colorado pikeminnow population the size estimated by Valdez and Ryel (2000). The prey biomass including catfish and carp, (if we assume that those species can be totally removed from the system and that biomass converted to appropriate prey such as native suckers and speckled dace), that the San Juan River would currently support a Colorado pikeminnow population lower than the current estimate for recovery.

The above results indicated that the bioenergetics approach was a viable tool that could be used to estimate the carrying capacity for pikeminnow in the San Juan River. Furthermore, it was important that a complete population model be developed that included both recruitment and production for the major native and nonnative fish species. Population models based on survival and reproductive potential for all age classes of the San Juan River fish community was incorporated into the SJRPM. The model described below includes flannelmouth and bluehead sucker, Colorado pikeminnow, razorback sucker, speckled dace, red shiner, fathead minnow, channel catfish and common carp.

MODEL DEVELOPMENT AND CALIBRATION

The San Juan River population model was developed over the period from 1998 through 2001. Since 2001, model refinements have been made to incorporate data specific to the San Juan River for the species of interest. The species in the model include the native fish currently present in the San Juan River including Colorado pikeminnow, razorback sucker, flannelmouth sucker, bluehead sucker and speckled dace. Nonnative species included in the model include channel catfish, carp and red shiner.

The population model uses STELLA as the modeling software to incorporate both the bioenergetic and population portion of the ecosystem (Figures 34-36). In addition, there are physical variables of habitat versus flow relationships, discharge, water temperature and turbidity that are linked to the model using Microsoft Excel spreadsheets. Data to initialize the model was derived from the San Juan River Monitoring Program. These data include initial population estimates or relative abundance for the fish included in the model as well as the physical data for water temperature, turbidity and discharge. The methods of collection and results have been previously discussed for these parameters.

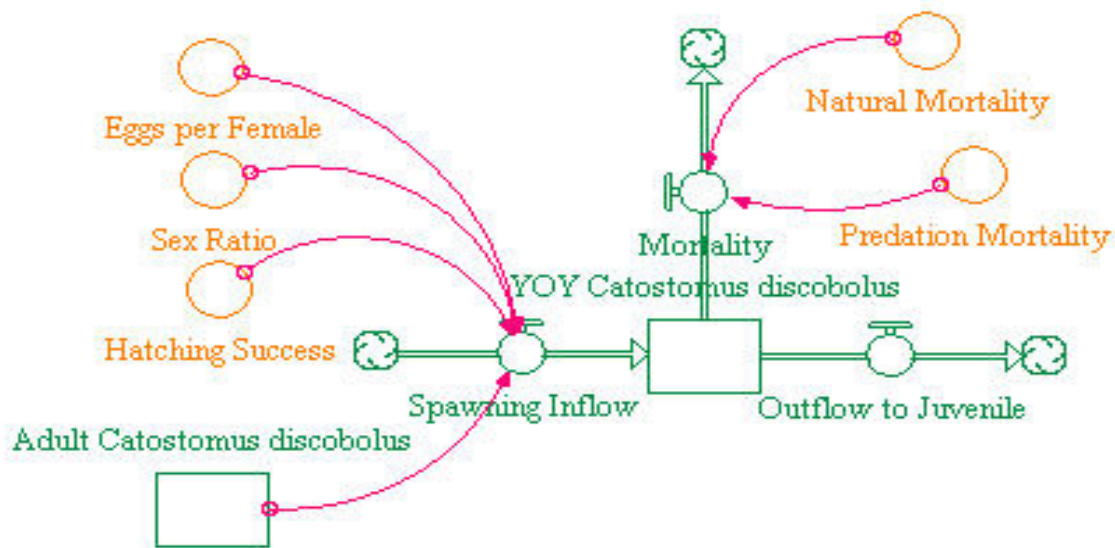

Figure 34. Example population dynamics for fish species with various interrelated parameters.

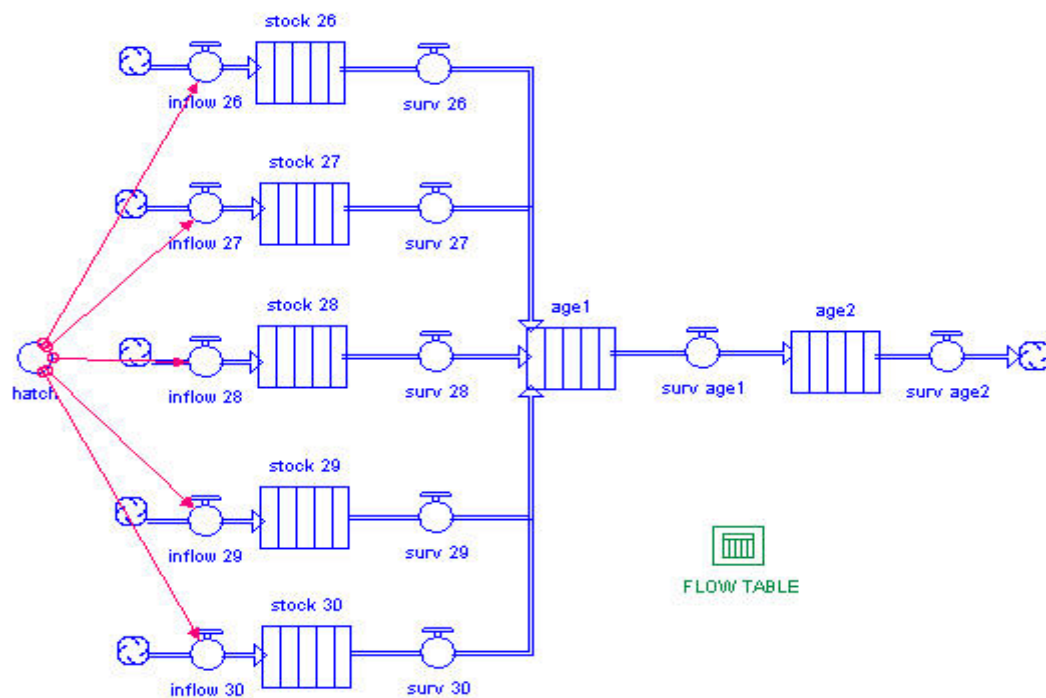

Figure 35. A more detailed view of the fish numeric population portion showing transfer from spawning to juvenile.

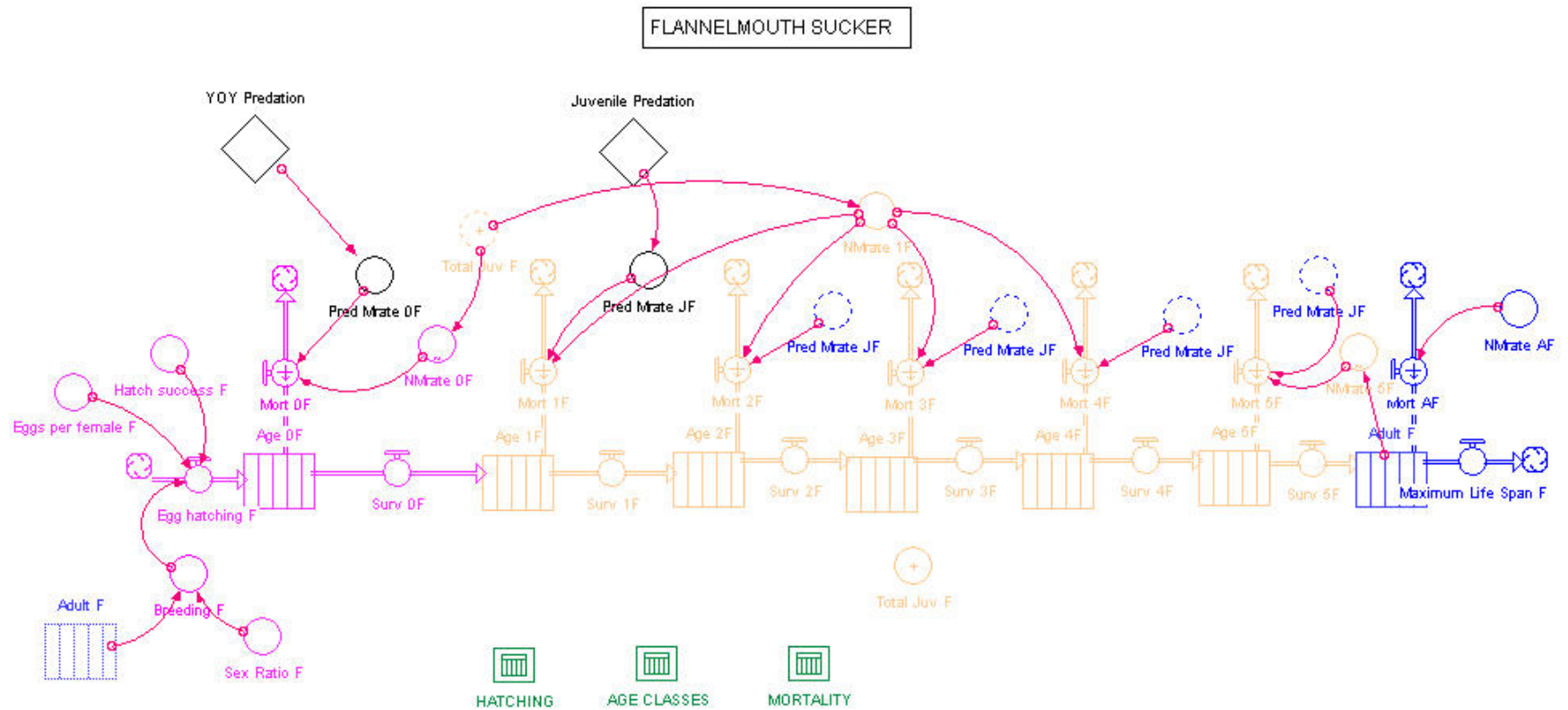

Figure 36. The complete population model for one selected fish species (flannelmouth sucker) in the model.

The model configuration consists of five model reaches to reflect the variability in habitat and populations throughout the San Juan River. Model results are reported for riverwide populations. Model calibration used mortality estimates and hatching success to adjust the model outputs to match the San Juan River monitoring data for the period 2002 through 2004. Model execution, as currently configured, consists of a STELLA model for each river reach, a single Microsoft Excel spreadsheet for input data for physical and biological data. There is a separate Microsoft Excel spreadsheet to link the output data for each model reach. The output is summarized for native species on a riverwide basis to compare the modeling results with collection results for the monitoring period. Additional model runs were made after calibration to evaluate Colorado pikeminnow and razorback sucker augmentation for the period 2001 through 2010. The specific code for the flannelmouth sucker example listed above is in Appendix E.

MODEL EXECUTION

The current configuration of the population model requires multiple copies of Stella and multiple MS Excel files to run concurrently. The following execution sequence:

Files

1. open SJRDDE.xls
dialog box opens, select update links.
2. open OUTPUTDDE.xls
dialog box opens, do NOT update links
3. open Stella Model for each reach in a separate copy of Stella
dialog box opens, reestablish links

Running

1. in Reach 5, use Ctrl R to begin running model, it will take several seconds but you will see no onscreen progress report. It pauses at 26 or 27 time steps.
2. migrate to OUTPUTDDE.xls
Under the Edit menu select Links
Dialog box opens
use Ctrl A to select all links
select update values (it initially shows #N/A in the worksheet but is updated when you close.)
Close dialog box.
3. in Reach 4, use Ctrl R to begin running model.
4. migrate to OUTPUTDDE.xls
Under the Edit menu select Links
Dialog box opens
use Ctrl A to select all links
select update values (it initially shows #N/A in the worksheet but is updated when you close.)
Close dialog box.
5. in Reach 3, use Ctrl R to resume running model, it will once again pause after 26 or 27 time steps.
6. migrate to OUTPUTDDE.xls

- Under the Edit menu select Links
Dialog box opens
use Ctrl A to select all links
select update values (it initially shows #N/A in the worksheet but is updated when you close.)
Close dialog box.
3. in Reach 2, use Ctrl R to resume running model.
4. migrate to OUTPUTDDE.xls
Under the Edit menu select Links
Dialog box opens
use Ctrl A to select all links
select update values (it initially shows #N/A in the worksheet but is updated when you close.)
Close dialog box.
3. in Reach 1, use Ctrl R to resume running model.
4. migrate to OUTPUTDDE.xls
Under the Edit menu select Links
Dialog box opens
use Ctrl A to select all links
select update values (it initially shows #N/A in the worksheet but is updated when you close.)
Close dialog box.

Repeat sequence in reverse order 2 – 3 – 4 – 5.

Repeat this sequence for the number of years of simulations.

Model Runs

The results of the initial model runs show that population and biomass estimates with reasonable confidence intervals can be obtained using the above methods (Figures 37-39). Specific population estimates by size class (YOY, juvenile and adult) were made using the data obtained at the three river reaches. This additional population effort provided additional information for use in refining the correlation between population estimates and relative abundance data.

Population dynamics of lotic fish communities are largely a function of the condition of and changes in their physical environment and the resulting responses in both primary (phytoplankton and periphyton) and secondary (zooplankton, micro- and macro invertebrates) production, and upon which these fishes rely to varying degrees for forage. Although the importance of these relationships are universally recognized by fisheries researchers, these lower trophic levels and the physical processes which influence them are often poorly understood in many aquatic systems. Yet these physical (substrate characteristics, temperature, water transparency, dissolved oxygen, etc.) and biological components of the ecosystem form the framework within which fish populations exist

Population estimates for speckled dace (*Rhinichthys osculus*) captured from riffle habitat at Hatch Trading Post

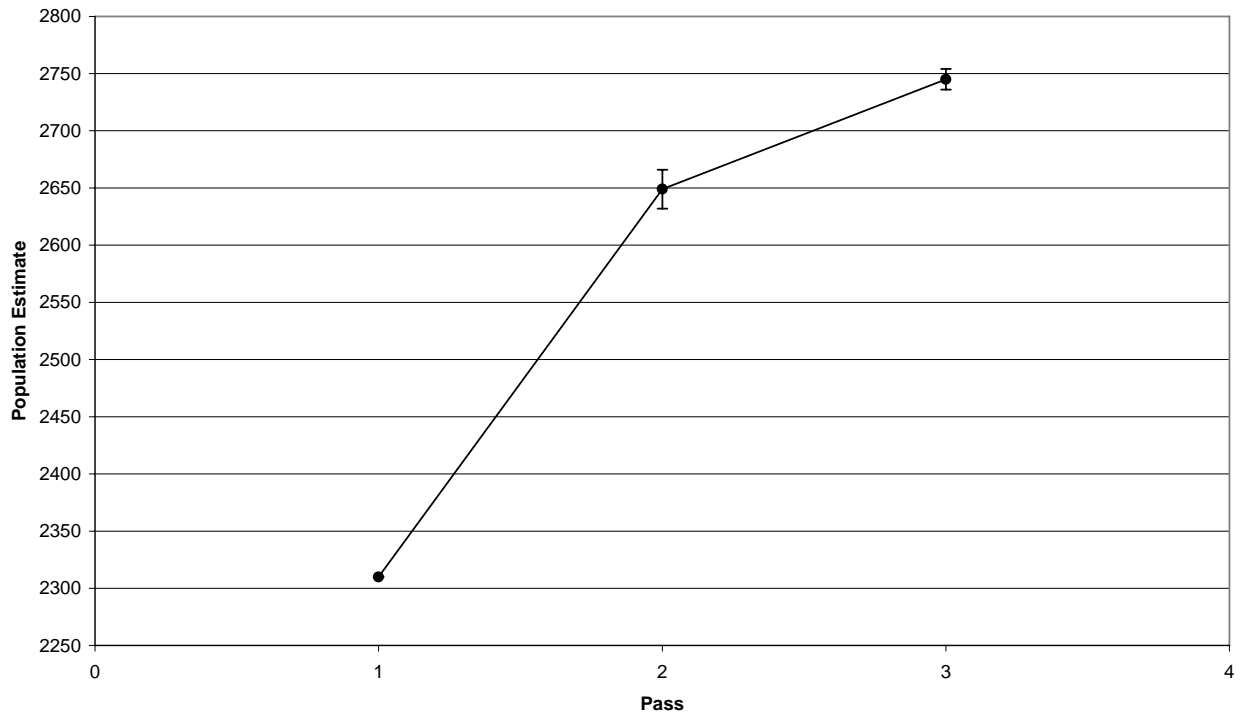

Figure 37. Speckled dace population estimate for riffle habitat, Reach 6, 1998.

Population estimates for flannelmouth suckers (*Catostomus latipinnis*) captured from riffle habitat at Hatch Trading Post

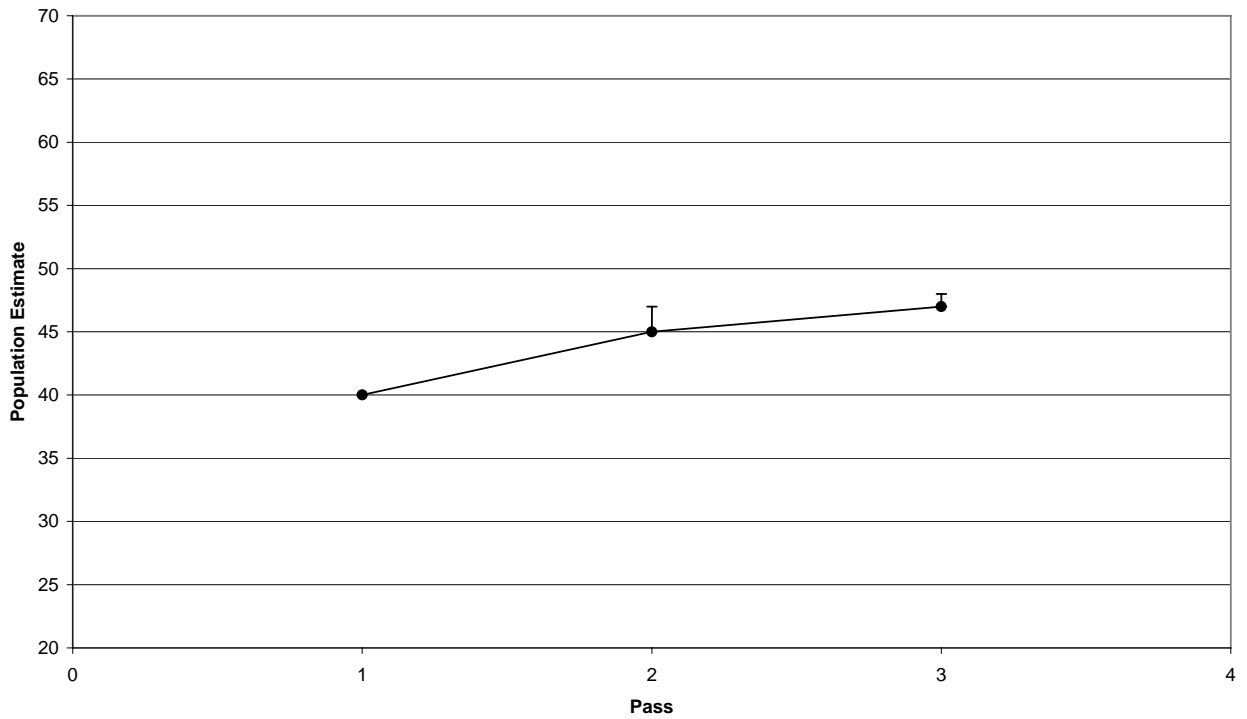

Figure 38. Flannelmouth sucker population estimate for riffle habitat, Reach 6, 1998.

Population estimates for flannemouth suckers (*Catostomus latipinnis*) captured during boat electroshocking at Hatch Trading Post

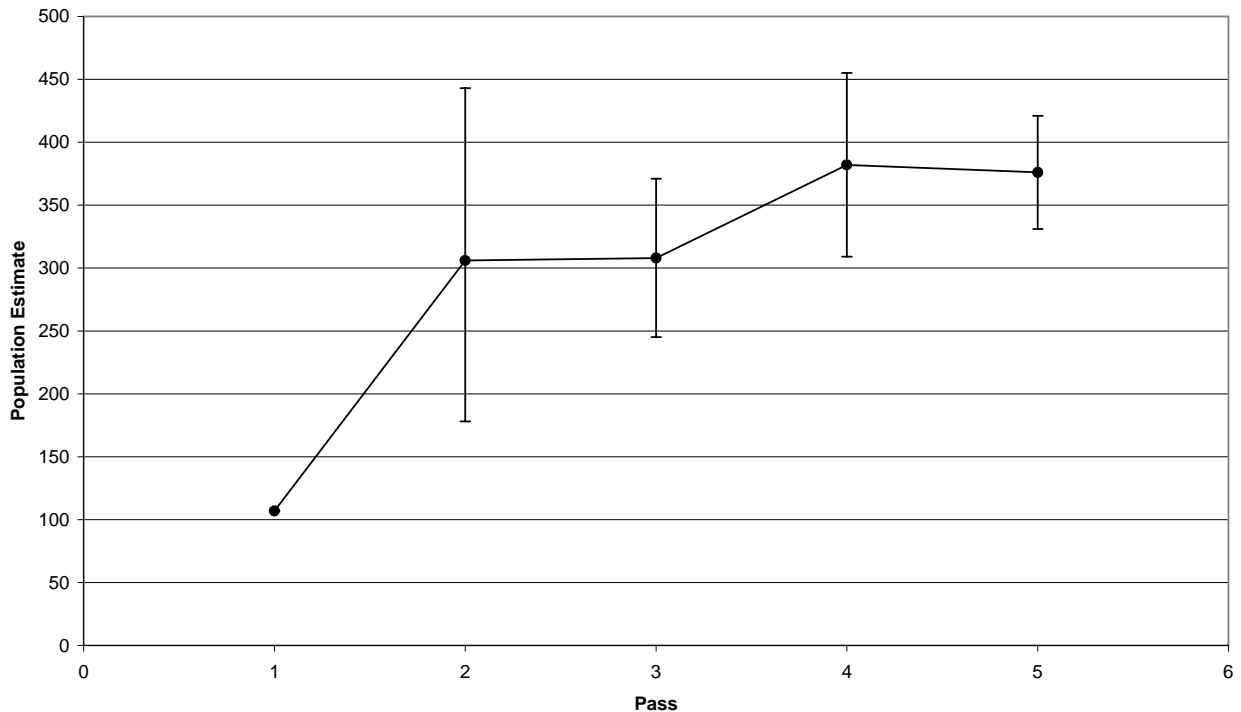

Figure 39. Flannemouth sucker population estimate (number per mile) for Reach 6, 1998.

and function. In the San Juan and Animas Rivers, these factors are highly influenced by the flow regime associated with the annual spring runoff as well as summer storm events. This influence of the flow regime makes the study of these physical and biological components of the ecosystem especially relevant in rivers where the management of flow is considered vital to the health of the of fish population of concern.

Furthermore, studies conducted by Ecosystems Research Institute in the San Juan River (Bliesner and Lamarra 1996, Holden 1998) and in the Colorado River with U.S. Fish and Wildlife Service (Lamarra 1998, Osmundson and Scheer 1997, Osmundson 1998) have illustrated the value of quantifying these environmental factors toward better understanding trends in the abundance and condition of the species in the fish community. Within the SJRPM, data on the trophic structure of all ecosystem components was considered and, where relevant, incorporated. Considering the influence of the flow regime in these environmental factors and in turn their influence on the fish community it is critical to quantify the detrital, primary, and secondary biomass dynamics in order for the populations goal model to be used as a management tool and to accurately estimate the carrying capacity of the San Juan and Animas Rivers for Colorado pikeminnow.

SENSITIVITY ANALYSIS

Model sensitivity analysis was conducted on Age 0 mortality rates to determine the effect of early life stage mortality on the juvenile and adult population numbers.

Table 11. Comparison of 99% and 90% mortality of Age 0 Colorado pikeminnow.

Model Outputs-300,000 per year, 99% Age 0 Mort

	Juv B	Adlt B	Juv F	Adlt F	Juv CP	Juv 6	Juv 7	Adlt Cp
Init	17983	5557	28150	24112	0	0	0	61
2001	53882	5244	36132	22942	0	0	0	52
2002	31759	4998	30471	21131	6634	0	0	41
2003	22659	6234	23864	23912	8293	0	0	33
2004	19318	6772	24225	23109	8865	0	0	26
2005	16494	10338	23876	21499	9137	0	0	21
2006	19326	10487	23073	20106	9278	0	0	17
2007	20032	9709	21710	18818	9364	90	0	14
2008	20043	9102	20489	17707	9418	114	59	13
2009	19787	8836	19719	16693	9434	111	83	49
2010	19265	8918	18816	15734	9505	109	79	99

Model Outputs-300,000 per year, 90% Age 0 Mort

	Juv B	Adlt B	Juv F	Adlt F	Juv CP	Juv 6	Juv 7	Adlt Cp
Init	17983	5557	28150	24112	0	0	0	61
2001	53882	5244	36132	22942	0	0	0	52
2002	31759	4998	30471	21131	38459	0	0	41
2003	22659	6234	23864	23912	48085	0	0	33
2004	19318	6772	24225	23109	51395	0	0	26
2005	16477	10338	23769	21499	52946	0	0	21
2006	19067	10487	22668	20106	53769	0	0	17
2007	19185	9710	20718	18818	54264	533	0	14
2008	19412	9103	19850	17706	54581	661	341	13
2009	19182	8837	19204	16682	54736	658	472	228
2010	18567	8894	18223	15689	56861	624	469	531

Model calibration included adjustment of parameters for hatching success and mortality through an iterative process and output for each fish species was compared to the monitoring data as collected for the years 2002 through 2004. The model replicated the monitored data best for flannelmouth sucker adults and razorback sucker (Figures 40-47). Examination of the model over a ten-year time period shows that the model is stable and that the populations for the two native sucker species which are most abundant show relative stability and replicate numbers as they have been found in the monitoring collections (Figure 45).

Bluehead Sucker Juveniles Model vs. Monitoring Estimates

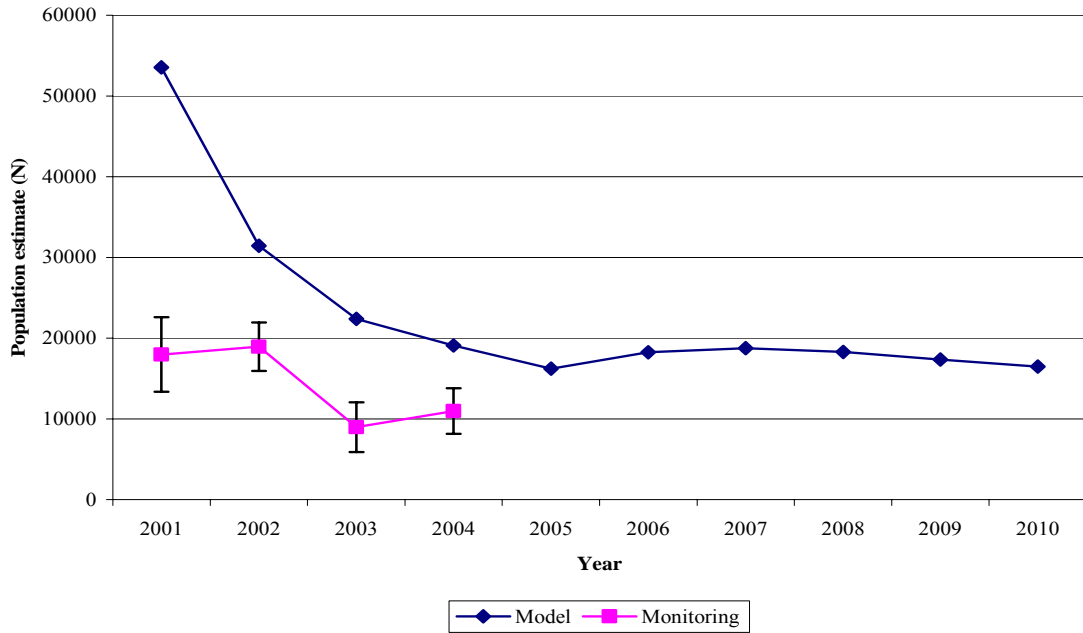

Figure 40. Comparison of model versus monitored bluehead sucker juvenile abundance.

Bluehead Sucker Adults Model vs. Monitoring Estimates

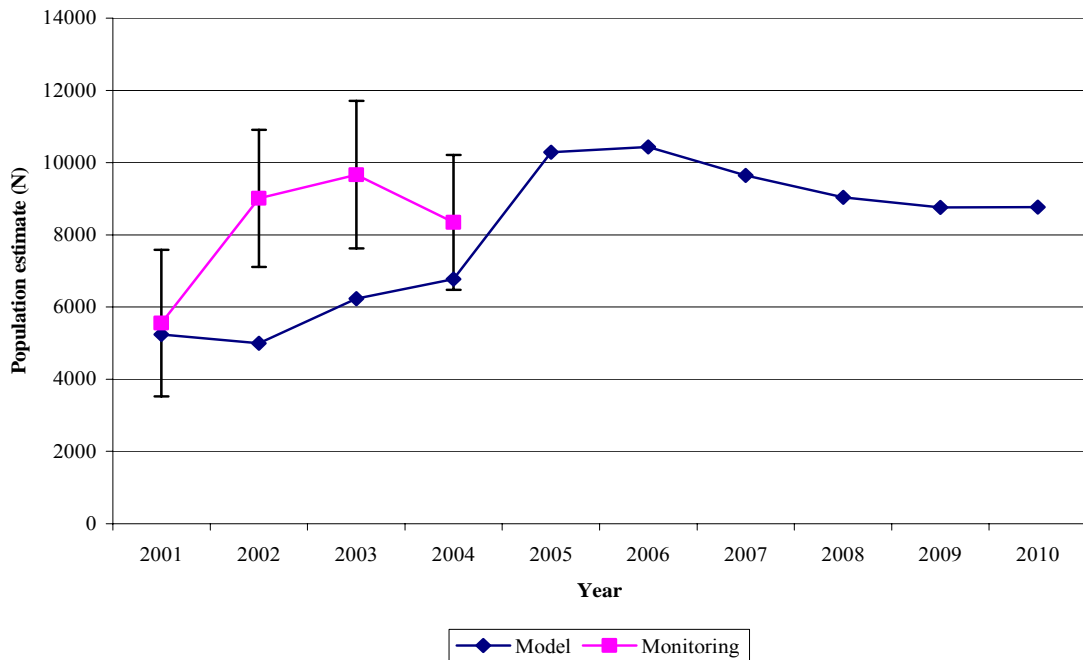

Figure 41. Comparison of model versus monitored bluehead sucker adult abundance.

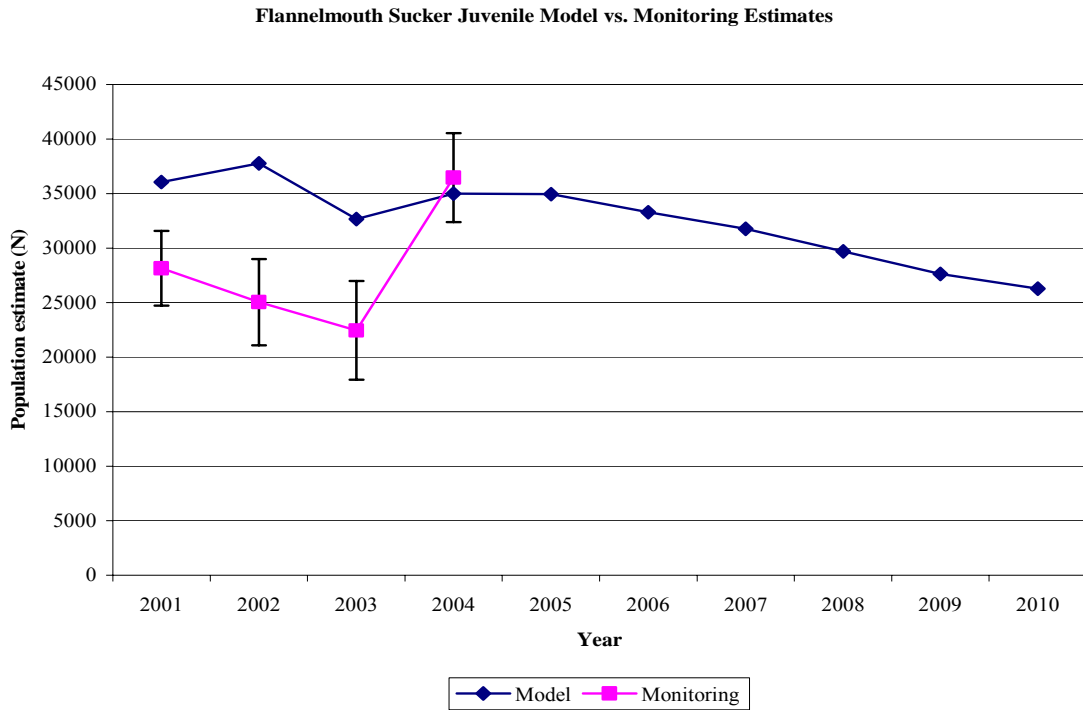

Figure 42. Comparison of model versus monitored flannemouth sucker juvenile abundance.

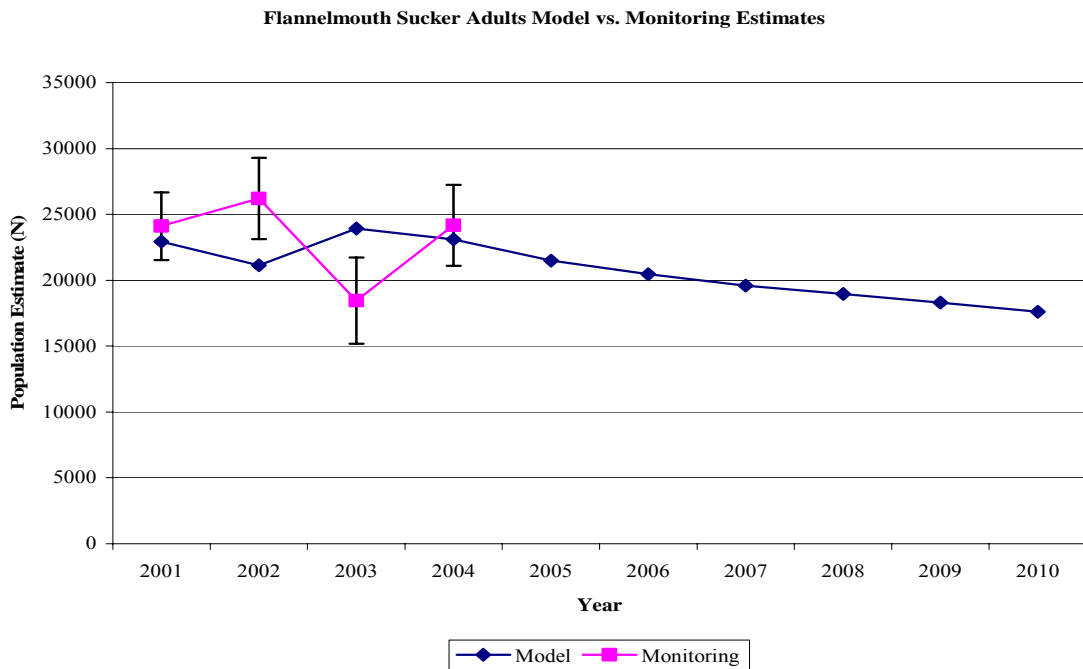

Figure 43. Comparison of model versus monitored flannemouth sucker adult abundance.

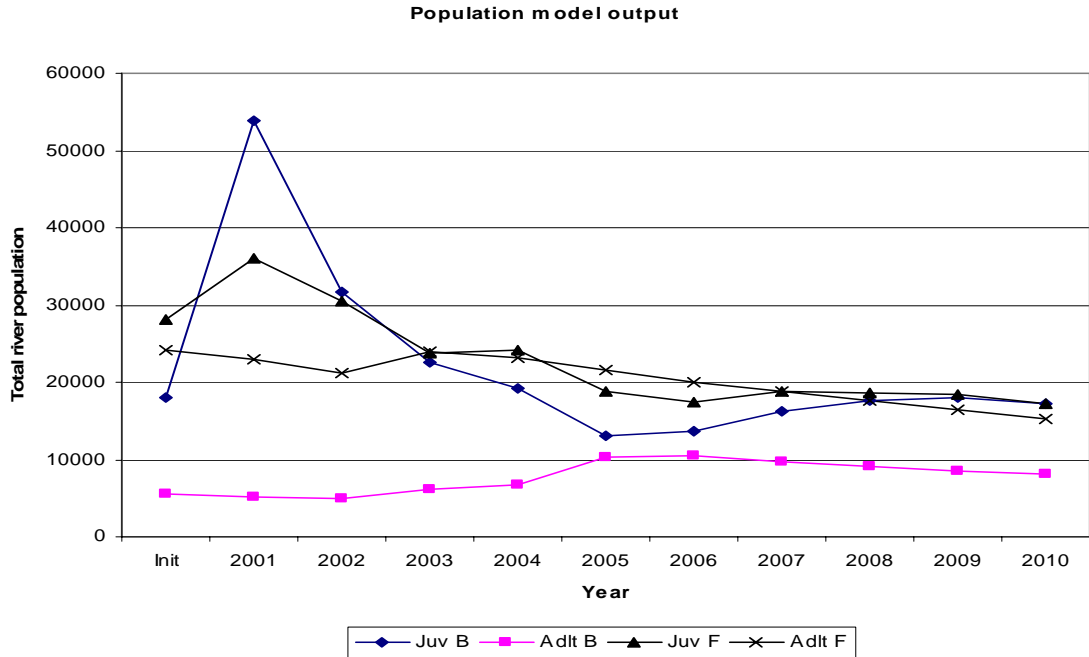

Figure 44. Model predicted abundance for native bluehead (JuvB and Adlt B) and flannelmouth (Juv B and Adlt B) sucker species 2001-2010.

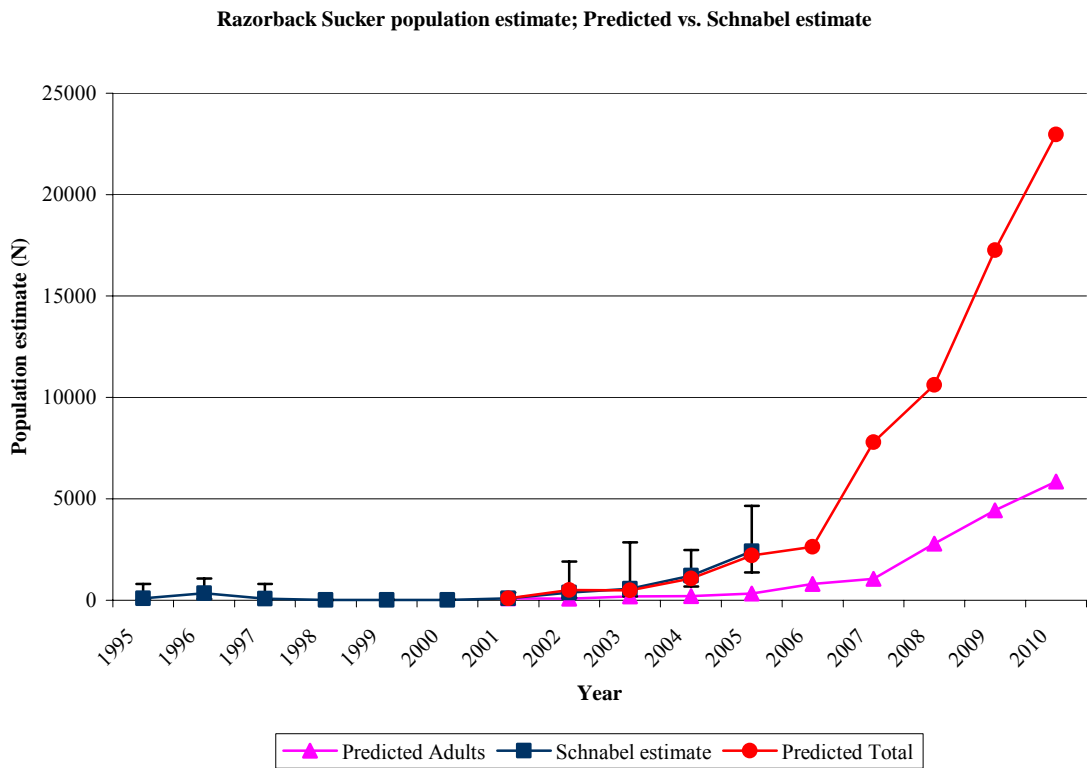

Figure 45. Comparison of monitored versus modeled razorback sucker populations.

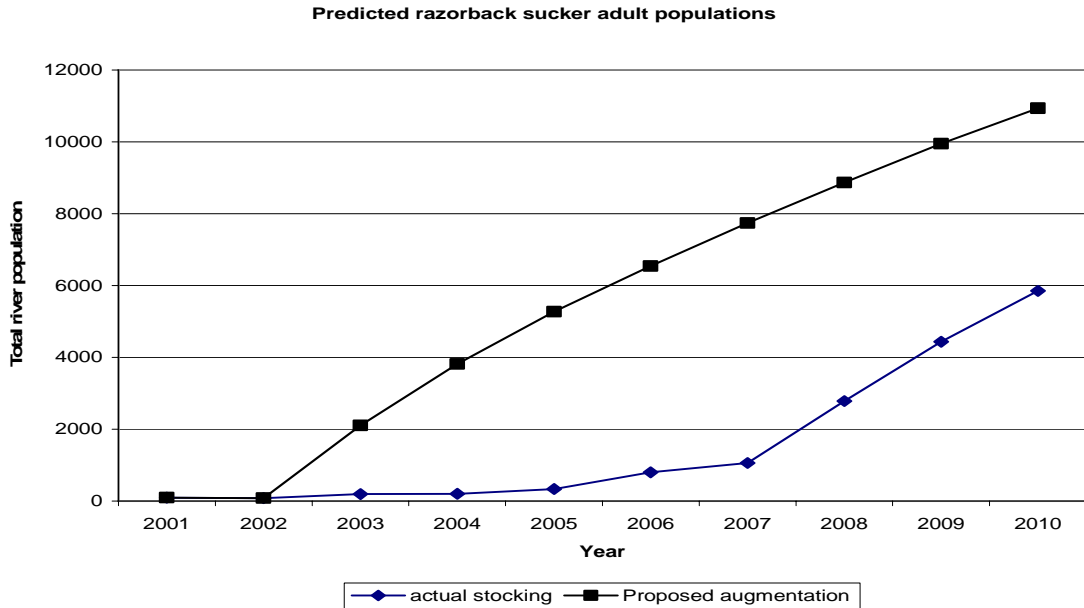

Figure 46. Model predicted razorback sucker adult population with existing augmentation and with augmentation as specified in augmentation plan.2001-2010.

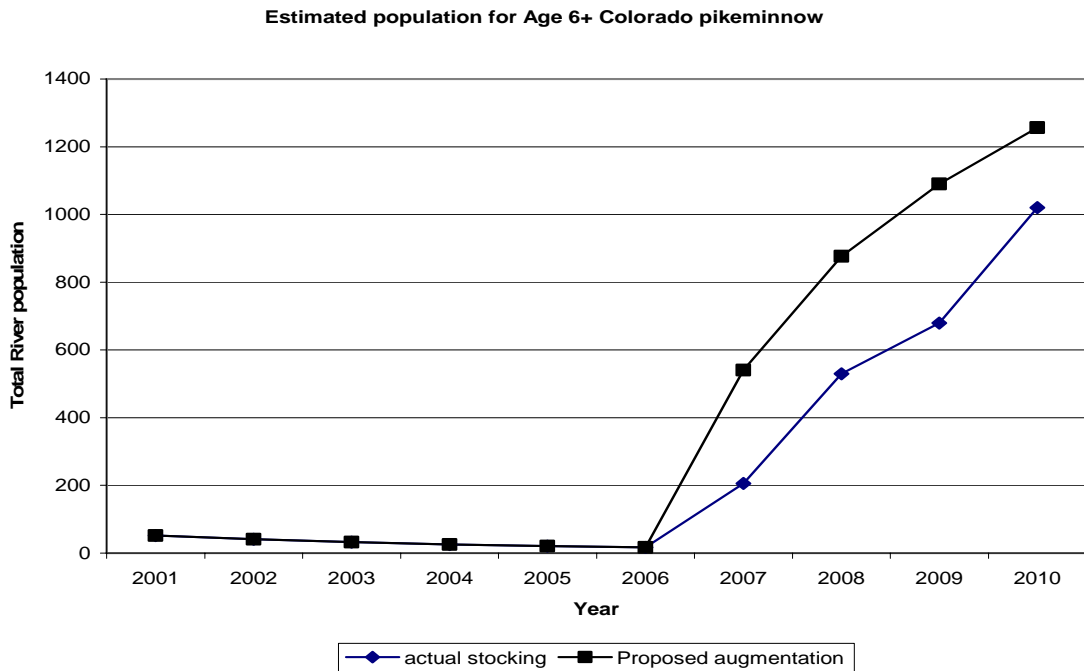

Figure 47. Model predicted Age 6+ Colorado pikeminnow population with existing augmentation and with augmentation as specified in augmentation plan.2001-2010.

Model runs conducted in 2005 included an evaluation of the stocking for razorback sucker as well as Colorado pikeminnow. Two separate runs were made for evaluation of the augmentation program. The first run consisted of using actual stocking numbers from the years 2001 through 2005 and then the specified augmentation numbers of 300,000 young-of-the-year Colorado pikeminnow and 5,000 razorback sucker for the years 2006 through 2010. This model run predicted that the adult razorback sucker recovery goal number could be met in the year 2010 (Table 12, Figure 46). The Colorado pikeminnow number was slightly lower than the 800 adult Colorado pikeminnow although the total for six- and seven-year old pikeminnow as well as adults exceeds the recovery goal in the year 2010 (Figure 47).

An additional model run using the specified augmentation numbers was conducted to evaluate whether the recovery goals would have been met sooner and shown using the actual stocking numbers. As with the run using actual stocking numbers, adult razorback sucker do not meet the recovery goals although if the 5,000 per year sub-adults would have been stocked, it appears that the adult numbers would have been reached in 2005 or 2006 (Table 13, Figure 46). The predicted Colorado pikeminnow population in 2009 is nearly double what was seen when using actual stocking numbers (Figure 47).

Truncated model runs were used to compare the stocking of larger age 1 or age 2 Colorado pikeminnow to determine if that larger size class would result in a more rapid reach of the recovery goal number. Due to the high mortality rates for 1 and 2 year old fish, as derived from the existing data, it would require extremely high numbers of those size classes to be stocked to make a significant difference from the populations that result from stocking young-of-the-year fish.

The native sucker populations were also modeled in conjunction with these model runs. The full suite of native species, as well as the major nonnatives, was modeled as a complete data set. There was a slight reduction in native sucker populations, both for juveniles and adults, with the augmentation program and conclusion of the adult razorback sucker. It appears that there may be some resource competition from those species and this is based on the analysis that razorback sucker and the two native sucker species would have a common food requirement.

It appears that both the razorback sucker and Colorado pikeminnow should reach the population goal near the year 2010, assuming the augmentation will continue from 2006 through 2010 at the proposed augmentation numbers of 300,000 young of the year Colorado pikeminnow and 11,000 sub adult razorback sucker. The Colorado pikeminnow may take one or two years longer than the year 2010 to reach the 800 adult Colorado pikeminnow as specified in the recovery goals.

Table 12. Predicted populations with Colorado pikeminnow and razorback sucker actual augmentation numbers 2000 – 2005.

Model Outputs- using Actual Stocking Numbers														
	Bluehead sucker		Flannemouth sucker		Channel catfish		Colorado pikeminnow			Common Carp		Razorback		
	Juvenile	Adult	Juvenile	Adult	Juvenile	Adult	Juvenile	Age 6	Age 7	Age 8+	Juvenile	Adult	Juvenile	Adult
Init	17983	5557	28150	24112	16092	13284	0	0	0	61	6884	9134	0	108
2001	53550	5244	36050	22942	9437	15020	0	0	0	52	9165	8843	0	96
2002	31445	4998	37768	21131	19265	14586	13953	0	0	41	9255	8445	431	81
2003	22399	6234	32676	23915	21012	13049	30526	0	0	33	9989	7594	291	195
2004	19089	6772	34994	23110	20843	11104	30918	0	0	26	10266	7027	878	202
2005	16224	10290	34937	21494	18685	10259	44622	0	0	21	10539	6581	1871	336
2006	18277	10432	33285	20458	17402	9512	52027	0	0	17	10823	6166	1827	800
2007	18768	9647	31763	19597	16395	8816	52977	193	0	13	11037	5799	6725	1061
2008	18294	9037	29714	18948	15433	8116	53557	393	126	11	10239	5485	7838	2785
2009	17358	8760	27641	18302	14513	7484	53944	337	254	89	9415	5215	12832	4430
2010	16477	8771	26288	17614	13601	6904	55060	571	219	230	8303	4966	17109	5850

Table 13. Predicted populations with Colorado pikeminnow and razorback sucker augmentation numbers as specified in the augmentation plans.

Model Outputs - Using full augmentation numbers														
	Bluehead sucker		Flannemouth sucker		Channel catfish		Colorado pikeminnow			Common Carp		Razorback		
	Juvenile	Adult	Juvenile	Adult	Juvenile	Adult	Juvenile	Age 6	Age 7	Age 8+	Juvenile	Adult	Juvenile	Adult
Init	17983	5557	28150	24112	16092	13284	0	0	0	61	6884	9134	0	108
2001	53550	5244	36050	22942	9437	15020	0	0	0	52	9165	8843	0	96
2002	31445	4998	37768	21131	19265	14586	38449	0	0	41	9255	8445	4982	81
2003	22399	6234	32676	23915	21012	13049	47999	0	0	33	9989	7594	6450	2105
2004	19091	6772	34995	23110	20843	11104	51190	0	0	26	10266	7027	10915	3816
2005	15876	10287	34409	21494	18685	10259	52630	0	0	21	10539	6581	15787	5269
2006	18159	10431	33208	20458	17402	9512	53359	0	0	17	10823	6166	20068	6540
2007	18802	9647	31958	19598	16395	8816	53775	527	0	13	11037	5799	24044	7738
2008	18610	9035	30619	18942	15433	8116	54029	527	338	11	10239	5485	27216	8865
2009	18041	8722	29285	18265	14513	7484	54321	527	337	225	9415	5215	30608	9947
2010	17370	8737	28245	17588	13601	6904	57145	524	337	395	8303	4966	33556	10933

CONCLUSIONS

- The San Juan River primary productivity
 - Detrital based
 - Light Limited
- Secondary producers
 - Majority of the invertebrates fall in 4 to 5 groups of insects.
- Fish populations in the current trophic structure are not limited by invertebrate production
- Reliable fish population estimates can be made using multiple pass removal in the main channel and individual habitats.
- The SJRPM can replicate the San Juan River fish populations
- The model is a tool that can be used to evaluate management alternatives but it requires interpretation based on the monitoring and population data being collected now and into the future.
- The San Juan River should support the razorback and Colorado pikeminnow populations specified in the Recovery Goals.
- The SJRPM predicts that the Recovery Goals can be met in the next five to eight years for razorback sucker and Colorado pikeminnow.

RECOMMENDATIONS

- San Juan River monitoring should begin collection of fish population estimates rather than relative abundance data, especially for juvenile and adult life stages.
- Species specific data is needed for the following parameters to better refine the trophic, growth and reproductive dynamics.
- Growth rate for native species based on food consumption and water temperature
- Fecundity of native species, especially the native suckers
- Length at age information based on individual cohorts and confirmed by definitive aging
- SJRPM code should be converted to Visual Basic or other appropriate model code to facilitate model execution, updates and enhancements.

LITERATURE CITED

- Angradi T.R. 1994. Trophic linkages in the lower Colorado River: multiple stable isotope evidence. *N. Amer. Benthol. Soc.* 13(4) 479-495.
- Bestgen, K.R., R.T. Muth, and M.A. Trammell. 1998. Downstream transport of Colorado squawfish larvae in the Green River drainage: temporal and spatial variation in abundance and relationships with juvenile recruitment. Final Report. Colorado River Recovery Implementation Program, Project No. 32.
- Bevelhimer, M.S., R.A. Stein, and R.F. Carline. 1985. Assessing significance of physiological differences among three esocids with a bioenergetics model. *Canadian Journal of Fisheries and Aquatic Sciences* 42:57-69.
- Brandt, S.B., D.M. Mason, E.V. Patrick, R.L. Argyle, L. Wells, P.A. Unger and D.J. Stewart. 1991. Acoustic measures of the abundance and size of pelagic planktivores in Lake Michigan. *Canadian Journal of Fisheries and Aquatic Sciences* 48:894-908.
- Britton L.J. and P.E. Greeson. 1987. Techniques of Water Related Investigations of the United States Geological Survey. USGS B-8040-85 Chapter A4, pages 255-263
- Cabana, G. and J. B. Rasmussen. 1996. Comparison of aquatic food chains using nitrogen isotopes. *Proc. Natl. Acad. Sci.* (93) 10844-1-847.
- Carline, R.F. 1987. Simplified method based on bioenergetics modeling to estimate food consumption by largemouth bass and northern pike. *Transactions of the American Fisheries Society* 116:224-231.
- Hansen, P.C., T.B. Johnson, D.E. Schindler, and J.F. Kitchell. 1997. Bioenergetics model 3.0 for windows. University of Wisconsin, Sea Grant Institute, Technical Report WISCU-T-97-001, Madison.
- Hartman, K.J., and S.B. Brandt. 1995. Comparative energetics and the development of bioenergetics models for sympatric estuarine piscivores. *Canadian Journal of Fisheries and Aquatic Sciences* 52:1647-1666.
- Hynes, H.B.N. and M.J. Coleman. 1968. A simple method of assessing the annual production of Stream benthos. *Limnology and Oceanography* 13:569-573.
- Lindeman, R. L. 1942. The trophic dynamic aspect of ecology. *Ecology* 23(4): 399-418
- Mann, K. H. 1965. Energy transformation by a population of fish in the River Thames. *J. Anim. Ecology.* 34:253-275
- Miller, W.J., V. Lamarra. 2000. Preliminary Draft - A Method for Estimating Population Goals for Colorado Pikeminnow in the San Juan River. Report presented

to the biology committee San Juan Recovery Implementation Program. May 26, 2000.

- Miller, W.J. and J.A. Ptacek. 2000. Colorado pikeminnow habitat use in the San Juan River, New Mexico and Utah. Final Report. Miller Ecological Consultants, Inc. Fort Collins, Colorado.
- Nesler, T.P. 1995. Interactions between endangered fishes and introduced gamefishes in the Yampa River, Colorado, 1987-1991. Colorado River Recovery Implementation Program, Project No. 91-29.
- Ney, J.J. 1993. Bioenergetics modeling today: growing pains on the cutting edge. *Transactions of the American Fisheries Society* 122:736-748.
- Osmundson, D.B., Ryel R.J., Lamarra V.A., and J. Pitlick. 2002. Flow-sediment-biota Relations: Implications for River Regulation effects on native fish Abundance. *Ecological Applications* Vol. 12, No.6 pp 1719-1739.
- Orlando, Sarnelle. 2003. Nonlinear Effects of an Aquatic Consumer: Causes and Consequences. *The American Naturalist*, Vol. 161, pages 478–496
- Peterson, J. B. and B. Fry. 1987. Stable isotopes in Ecosystem Studies. *Amer. Rev. Ecol. Syst.* 18: 293-320.
- Petersen, J.H. and D.L. Ward. 1999. Development and corroboration of a bioenergetics model for northern pikeminnow feeding on juvenile salmonids in the Columbia River. *Transactions of the American Fisheries Society* 128:784-801.
- Rice, J.A., J.E. Breck, S.M. Bartell, and J.F. Kitchell. 1983. Evaluating the constraints of temperature, activity, and consumption on growth of largemouth bass. *Environmental Biology of Fishes* 9:263-275.
- Shuter, B.J. and J.R. Post. 1990. Climate, population viability, and the zoogeography of temperate fishes. *Transactions of the American Fisheries Society* 119:314-336.
- Stewart, D.J. and M. Ibarra. 1991. Predation and production by salmonine fishes in Lake Michigan, 1978-88. *Canadian Journal of Fisheries and Aquatic Sciences* 48:909-922.
- Valdez, R.A. and R.J. Ryel. 2000. Summary of recovery goals for the four endangered fishes of the Colorado River Basin. SWCA, Inc., Logan, Utah.
- Vanicek, C.D. 1967. Ecological studies of native Green River fishes below Flaming Gorge Dam. Thesis, Utah State University, Logan, Utah.

- Wahl, D.H. and R.A. Stein. 1991. Food consumption and growth of three esocids: field tests of a bioenergetic model. *Transactions of the American Fisheries Society* 120:230-246.
- Welch, H.E. 1968. Use of modified diurnal curves for the measurement of metabolism in standing water. *Limnology and Oceanography* 13(5) p. 679-687
- Whitledge, G.W. and R.S. Hayward. 1997. Laboratory evaluation of a bioenergetics model for Largemouth Bass at two temperatures and feeding levels. *Transactions of the American Fisheries Society* 126:1030-1035.
- Zanden, M. J. ,Cabana, G., and J.B. Rasmussen 1997. Comparing trophic position of freshwater fish calculated using stable nitrogen isotope ratios and literature dietary data. *Can. J. Fish. Aquat. Sci.* 54:1142-1158.

APPENDIX A – Model Parameters And Data Source For Stella Model

Fathead Minnow parameters

Parameter	Value	Stella Value	Source	Comments
Eggs per female	1218	87	Isaak 1961, Carlson 1967	Combined and averaged eggs per female values from both sources and divided the value by number of spawning weeks (14) to get the eggs per female per spawning week.
Sex ratio (f:m)	1:1.4	0.42	Payer and Scalet 1978	Used the average sex ratio from the three monthly values. Divided the number of females by the number of fish (I.e. 1/2.4)

Red Shiner Parameters

Parameter	Value	Stella Value	Source	Comments
Eggs per female	6177	441	Gale 1986	Divided eggs per female by number of spawning weeks (14) to get the number of eggs per female per spawning week
Sex ratio (f:m)				

Bluehead sucker parameters

Parameter	Value	Stella Value	Source	Comments
Eggs per female				
Adult 350 TL	6742	1348	McAda 1977	Average eggs per female for a 350 mm fish from three upper basin rivers. Number divided by number of spawning weeks (5) to get number of eggs per female per week.
Adult 450 TL	16886	3377	McAda 1977	Average eggs per female for a 450 mm fish from three upper basin rivers. Number divided by number of spawning weeks (5) to get number of eggs per female per week.
Sex ratio (f:m)	1:2	0.33	Maddux and Kepner 1988, Otis 1994	Divided the number of females by the number of fish (I.e. 1/3)

Flannelmouth sucker parameters

Parameter	Value	Stella Value	Source	Comments
Eggs per female				
Adult 450 TL	12685	2114	McAda and Wydoski 1985	Average eggs per female for a 450 mm fish from four upper basin rivers. Number divided by number of spawning weeks (6) to get number of eggs per female per week.
Adult 550 TL	25297	4216	McAda and Wydoski 1985	Average eggs per female for a 550 mm fish from four upper basin rivers. Number divided by number of spawning weeks (6) to get number of eggs per female per week.
Sex ratio (f:m)	1:2	0.33		Divided the number of females by the number of fish (I.e. 1/3)

Razorback sucker parameters

Parameter	Value	Stella Value	Source	Comments
Eggs per female	46740	6677	McAda and Wydoski 1980	Number divided by number of spawning weeks (7) to get number of eggs per female per week.
Sex ratio (f:m)	1:2.2	0.31	Tyus 1987, Tyus and Karp 1990	Averaged the sex ratio's from the two sources and divided the number of females by the number of fish (I.e. 1/3.2)
Hatching success			Marsh 1985	

Channel catfish parameters

Parameter	Value	Stella Value	Source	Comments
Sex ratio (f:m)	1:1	0.5		Divided the number of females by the number of fish (I.e. 1/2)
Eggs per female				
Adult 450 TL	11746	2349	Raibley and Jahn 1991	Average eggs per female for a 450 mm fish from Mississippi R. Number divided by number of spawning weeks (5) to get number of eggs per female per week.
Adult 700 TL	38004	7600	Raibley and Jahn 1991	Average eggs per female for a 700 mm fish from Mississippi R. Number divided by number of spawning weeks (5) to get number of eggs per female per week.
Hatching success				

Speckled dace parameters

Parameter	Value	Stella Value	Source	Comments
Eggs per female				
Adult 1	259	19	Johns 1963	Multiplied 5.7 eggs/mm female total length by average length of each adult group then divided the value by number of spawning weeks (14) to get the eggs per female per spawning week.
Adult 2	425	30		
Adult 3	584	42		
Adult 4	687	49		
Sex ratio (f:m)				

Common carp parameters

Parameter	Value	Stella Value	Source	Comments
Sex ratio (f:m)	1:1.8	0.36	Sweeney and McCrimmon 1966	Divided the number of females by the number of fish (I.e. 1/2.8)
Eggs per female				
Adult 500 TL	244371	40728		Average eggs per female for a 500 mm fish from Ontario. Number divided by number of spawning weeks (6) to get number of eggs per female per week.
Adult 700 TL	1203345	200557		Average eggs per female for a 700 mm fish from Ontario. Number divided by number of spawning weeks (6) to get number of eggs per female per week.

Spawning Weeks

Species	Beg	End	Spawning		Duration	Adult Age	Life Span
			Weeks for Stella	Incubation			
Colorado pikeminnow ¹	25-Jun	29-Jul	26-30	6 days	34 days	8	
Bluehead sucker	30-Apr	3-Jun	18-22			3	
Fathead minnow ²	25-Jun	30-Sep	26-39	3-5 d (18-30C)		1	
Flannelmouth sucker ³	30-Apr	10-Jun	18-23			6	
Razorback sucker ⁴	30-Apr	17-Jun	18-24				
Channel catfish ⁵	23-Jul	26-Aug	30-34			6	
Red shiner	10-Jun	9-Sep	23-36				
Common Carp	25-Jun	5-Aug	26-31				
Speckled Dace	10-Jun	9-Sep	23-36				

1)

2) Weeks were based on a spawning initiation water temp of 16°C and temp data for WY1995 from the four-corners thermograph

3) Weeks were based upon McAda 1977 and McAda and Wydoski 1985

4)

5) Weeks were based on spawning temperature requirements and temp data from four-corners thermograph as well as Platania larval capture data

Parameter values used in **Stella**

Parameter	Bluehead Sucker	Speckled Dace	Flannelmouth Sucker	Common Carp	Fathead Minnow	Red Shiner	Channel Catfish	Razorback Sucker	Colorado Pikeminnow
Sex Ratio F:M	1:2 (0.33)		1:2 (0.33)	1:1.8 (0.36)	1:1.4 (0.42)		1:1 (0.5)	1:2.2 (0.31)	1:2.4 (0.29)
Fecundity, Adlt 1	6742 (1348/wk)	259 (19/wk)	12685 (2114/wk)	244371 (40728/wk)	1218 (87/wk)	6177 (441/wk)	11746 (2349/wk)	46740 (6677/wk)	1
Fecundity, Adlt 2	16886 (3377/wk)	425 (30/wk)	25297 (4216/wk)	1203345 (200557/wk)			38004 (7600/wk)	46740 (6677/wk)	1
Fecundity, Adlt 3		584 (42/wk)							
Fecundity, Adlt 4		687 (49/wk)							
Hatch Success									
YOY Nmrte	1	1	1	1	1	1	1	1	1
Juv 1 Nmrte	1		1	1	1		1	1	1
Juv 2 Nmrte	1		1	1	1		1	1	1
Juv 3 Nmrte	1		1	1	1		1	1	1
Juv 4 Nmrte	1		1	1	1			1	1
Juv 5 Nmrte	1		1		1			1	1
Juv 6 Nmrte					1				1
Juv 7 Nmrte					1				1
Adult 1 Nmrte	1	1	1	1	1	0.94	1	1	1
Adult 2 Nmrte	1	1	1	1	1		1	1	1
Adult 3 Nmrte		1							
Adult 4 Nmrte		1							
Age at spawning	Age 6 (7th yr)	Age 1 (2nd yr)	Age 6 (7th yr)	Age 5 (6th yr)	Age 1 (2nd yr)	Age 1 (2nd yr)	Age 5 (6th yr)	Age 6 (7th yr)	Age 8 (9th yr)
Max Life Span	25	4	30	16	3	3	22	35	35
Adult 1	9 (468), 300-400 mm	1 (52)	13 (676), 400-500 mm	6 (312), 400-600 mm	103	103	11 (572), 300-600 mm	15 (780), < 500 mm	14 (728)
Adult 2	11 (572), 400-500 mm	1 (52)	12 (624), 500-600 mm	6 (312), > 600 mm	1	1	8 (416), > 600 mm	15 (780), > 500 mm	14 (728)
Adult 3	1	1 (52)	1	1	1	1	1	1	1
Adult 4	1	1 (51)	1	1	1	1	1	1	1
Length at age	Hist from Ryden 2005 (part)	1	Hist from Ryden 2005 (part)	1	1	1	MEC Ageing	1	Jackson 2005 (part)
Length-Weight Regr	1998-2001 MEC Data	1998-2001 MEC Data	1998-2001 MEC Data	1998-2001 MEC Data	1998-2001 MEC Data	1998-2001 MEC Data	1998-2001 MEC Data	1	Ryden 2000

Note 1 – Rate calculated from annual value. Mortality rates separated into weekly values

Length Ranges used to model age classes

For Population Estimates (traditional fish ageing)

Initial Length Range Time	Bluehead Sucker Fall	Speckled Dace Fall	Flannelmouth Sucker Fall	Common Carp Fall	Fathead Minnow at age	Red Shiner at age	Channel Catfish Fall	Colorado Pikeminnow Fall	Razorback Sucker Fall
Age 0	0-45	0-30	0-45	0-85	0-40	0-40	0-80	0-80	0-110
Age 1	45-90		45-90	80-200			80-180	80-170	110-210
Age 2	90-185		90-240	200-300			180-236	170-225	210-300
Age 3	185-265		240-340	300-400			236-270	225-280	300-400
Age 4	265-300		340-400				270-311	280-335	
Age 5								335-390	
Age 6								390-445	
Age 7								445-500	
Adult 1	>300	30-55	>400	>400	40-85	40-85	>300	>500	>400
Adult 2		55-80							
Adult 3		80-100							
Adult 4		100+							

For Growth (length at model age)

Initial Length Range	Bluehead Sucker	Speckled Dace	Flannelmouth Sucker	Common Carp	Fathead Minnow	Red Shiner	Channel Catfish	Colorado Pikeminnow	Razorback Sucker
Age 0	0-55	0-35	0-55	0-95	0-45	0-45	0-90	0-100	0-120
Age 1	55-100		55-100	95-210			90-190	100-180	120-220
Age 2	100-195		100-250	210-310			190-245	180-235	220-310
Age 3	195-275		250-350	310-410			245-275	235-290	310-410
Age 4	275-305		350-405					290-345	
Age 5								345-400	
Age 6								400-450	
Age 7								450-505	
Adult 1	350-355	35-60	450-455	500-525	45-85	45-85	450-480	550-555	450-455
Adult 2	425-430	60-85	550-555	625-650			650-665	650-655	550-555
Adult 3		85-105							
Adult 4		105-125							

Weight Ranges used to model age classes

Initial Length Range Time	Bluehead Sucker		Speckled Dace		Flannelmouth Sucker		Common Carp		Fathead Minnow	
	Model Age	Wt at length	Model Age	Wt at length	Model Age	Wt at length	Model Age	Wt at length	Model Age	Wt at length
Age 0	0	0	0	0.00	0	0	0	0	0	0
	55	1.53	35	0.33	55	1.35	95	11.54	45	0.79
Age 1	55	1.53			55	1.35	95	11.54		
	100	9.74			100	8.69	210	129.14		
Age 2	100	9.74			100	8.69	210	129.14		
	195	76.74			250	150.95	310	422.65		
Age 3	195	76.74			250	150.95	310	422.65		
	275	222.09			350	430.64	410	990.00		
Age 4	275	222.09			350	430.64				
	310	321.64			405	678.59				
Age 5										
Age 6										
Age 7										
Age 8										
Adult 1	350	468.05	35	0.33	450	942.27	500	1811.40	45	0.79
	355	489.03	60	1.73	455	975.28	525	2101.47	85	5.87
Adult 2	425	852.98	60	1.73	550	1760.80	625	3573.09		
	430	884.38	85	5.04	555	1811.15	650	4026.24		
Adult 3			85	5.04						
			105	9.64						
Adult 4			105	9.64						
			125	16.47						

Weight Ranges (continued)

Initial Length Range Time Age 0	Shiner		Catfish		Pikeminnow		Sucker	
	Model Age	Wt at length	Model Age	Wt at length	Model Age	Wt at length	Model Age	Wt at length
	0	0	0		0		0	
	45	0.84	90	5.79	100	9.16	120	23.71
			90	5.79	100	9.16	120	23.71
Age 1			190	51.64	180	52.80	220	131.26
			190	51.64	180	52.80	220	131.26
Age 2			245	108.71	235	116.91	310	345.61
			245	108.71	235	116.91	310	345.61
Age 3			278	157.38	290	218.82	410	761.00
			278	157.38	290	218.82		
Age 4					345	367.20		
					345	367.20		
Age 5					400	570.68		
					400	570.68		
Age 6					450	810.73		
					450	810.73		
Age 7					505	1143.28		
Age 8								
	45	0.84	450	644.68	550	1474.54	450	810.73
Adult 1	85	7.00	480	778.76	580	1727.47	455	837.87
			650	1891.94	650	2426.17	550	1474.54
Adult 2			665	2022.63	665	2596.90	555	1514.86
Adult 3								
Adult 4								

APPENDIX B – Population Model Life History, Bioenergetics And Population Parameter Data

Colorado Pikeminnow Life History information.

Species	Parameter	Value	Source	Comments
Colorado Pikeminnow	Sex Ratio F:M	1:2.4 (0.29)?	Hamman 1981	
		1:5.7 (0.15)	Seethaler 1978	USU collection
	Eggs per Female	82,576	Hamman 1989	Hatchery
		74,341	Hamman 1986	Hatchery
		45,000	Marsh 1985	Hatchery
		8,300	Hamman 1981	Wild (uninj)
		11,000	Hamman 1981	Wild (inj)
		7,854	Hamman 1981	Hatchery (inj)
		145,522 (754 mm)	Hamman 2003	Hatchery (inj)
	Hatching Success	0.025 (18-19C)	Hamman 1981	Hatchery
		0.65 (22-24C)	Hamman 1981	Wild (inj), raceway
		0.90 (20-21C)	Hamman 1981	Wild (inj), screen tray
		0.30 (20-21C)	Hamman 1981	Wild (uninj)
		0.59 (20-22C)	Hamman 1986	Hatchery (Heath)
		0.66 (20-22C)	Hamman 1986	Hatchery (Jar 1983)
		0.49 (20-22C)	Hamman 1986	Hatchery (Jar 1984)
		0.27 and 0.02 (20C)	Marsh 1985	Hatchery (two trials)
		0.0 and 0.9 (25C)	Marsh 1985	Hatchery (two trials)
		0.65 (18C), 0.74 (22C), 0.54 (26C), 0.38 (30C)	Bestgen and Williams 1994	Laboratory, from wild
	Incubation Time	6 day at 18C (50% hatching)	Bestgen and Williams 1994	Laboratory, from wild
		4.3 day at 22C (50% hatching)	Bestgen and Williams 1994	Laboratory, from wild
		4 day at 26C (50% hatching)	Bestgen and Williams 1994	Laboratory, from wild
		5 day (22 and 26°C), 6 day (18°C)	Bestgen and Bundy 1998	Laboratory
	egg to post larvae surv	0.01	Crowl and Bouwes 1998	Arbitrary
	Post hatch survival	0.83 (18C), 0.69 (22C), 0.88 (26C), 0.13 (30C) to 7d posthatch	Bestgen and Williams 1994	Laboratory, from wild
		see crowl and bouwes for more on fry survival		
	Age 0 overwinter	45%	Haines and Modde 1996	Green River, hatchery fish
	Fry survival	27.7-36%	Hamman 1989	Hatchery
	Fingerling survival	84.8-99.7%	Hamman 1989	Hatchery
	Age 1 survival	30%	Crowl and Bouwes 1998	Arbitrary
	Age 2 survival	40%	Crowl and Bouwes 1998	Arbitrary
	Age 3 survival	60%	Crowl and Bouwes 1998	Arbitrary
	Adult survival	79%	Osmundson and Burnham 1996	
		81%	Gilpin 1993	PVA analysis
		85%	Osmundson et al. 1997	Colorado River, CO
	Spawning Time	middle July	Miller and Ptacek 2000	San Juan River
		Initial spawn, 13 June to 1 July, 34 day mean duration	Bestgen et al. 1998	Lower Yampa River
		Initial spawn, 9 June to 24 June, 37 day mean duration	Bestgen et al. 1998	Lower Green River
		16.4 to 23.1C	Bestgen et al. 1998	Lower Yampa River
		19.8 to 23C	Bestgen et al. 1998	Lower Green River
		24 June to 14 August	Platania et al. 2000	San Juan River
		>503 mm (100%)	Seethaler 1978	USU Collection
		428-503 mm (76%)	Seethaler 1978	USU Collection
		<428 mm (0%)	Seethaler 1978	USU Collection
		Max Life Span	20-50yrs	Holden and Wick 1982
	26+ (765mm)		Scoppettone 1988	
	Diet	30+	Minckley 1991	Green River
Thermal Preferendum				

Colorado Pikeminnow Life History information. (continued)

adult	25.4°C	Bulkley et al. 1981	Hatchery
juvenile	24.6°C	Bulkley et al. 1981	Hatchery
Size (mm) at age	106 (2), 198 (3), 285 (4), 355 (5), 411 (6), 453 (7), 495 (8), 531 (9), 570 (10), 619 (11)	Seethaler 1978	Colorado River, CO
	71 (2), 172 (3), 269 (4), 342 (5), 400 (6), 449 (7), 486 (8), 518 (9), 552 (10), 600 (11)	Seethaler 1978	Yampa-Green River
	90 (2), 186 (3), 278 (4), 350 (5), 406 (6), 451 (7), 491 (8), 524 (9), 557 (10), 604 (11)	Seethaler 1978	Colorado and Yampa-Green
	94 (2), 150 (3), 220 (4), 286 (5), 345 (6), 396 (7), 440 (8), 478 (9), 514 (10), 554 (11)	Hawkins 1992	Colorado, White, Yampa, Green
	586 (12), 615 (13), 641 (14), 669 (15), 705 (16), 764 (17), 776 (18)	Hawkins 1992	Colorado, White, Yampa, Green
	44 (1), 95 (2), 162 (3), 238 (4), 320 (5), 391 (6), 454 (7), 499 (8),	Vanicek and Kramer 1969	Green River
	536 (9), 570 (10), 600 (11)	Vanicek and Kramer 1969	Green River
	71 (1), 181 (2), 233 (3), 315 (4), 376 (5), 424 (6), 456 (7)	Osmundson et al. 1997	Colorado River, CO
Growth rate (mm/year)	400-499 (33.4 mm/yr), 500-599 (13.9 mm/yr), 600-699 (9.9 mm/yr), 700-799 (13.1 mm/yr), 800-899 (4.2 mm/yr)	Osmundson et al. 1997	Colorado River, CO
Age 0CP			
Age 1CP			
Age 2CP			
Age 3CP			
Age 4CP			
Age 5CP			
Age 6CP			
Age 7CP			
Adult CP			
Pred Mrate 0CP			
Pred Mrate JCP			
NMrate 0CP			
NMrate 1CP			
NMrate 2CP			
NMrate ACP			

Red shiner Life History information.

Species	Parameter	Value	Source	Comments	
Red Shiner	Sex Ratio F:M				
	Eggs per Female	6177/year	Gale 1986		
	Hatching Success				
	Spawning Time	June-Aug April-September	Gale 1986 Farringer et al. 1979	Lab Texas and Oklahoma	
	Age of Maturity	1 (mature next spawn) (30 mm) >30 mm >30 mm (Age 1) at least some same summer	Farringer et al. 1979 SJR Size Class Info Gido and Propst 1999 Marsh-Matthews et al. 2002	Texas and Oklahoma San Juan River Artificial stream	
	Max Life Span	2 yrs (2 spawns) Age 3	Farringer et al. 1979 Quist and Guy 2001	Texas and Oklahoma Kansas	
	Diet	Inverts (>90%) and Debris/Detritus (<10%)		Greger and Deacon 1988	Virgin River
		Larval fish (15% of specimens)		Ruppert et al. 1993	Yampa, Green Rivers
		Larval fish (0.97% of specimens (n=414))		Brandenburg and Gido 1999 R.T. Muth pers. comm in	San Juan River
		Maximum size of prey (<20 mm)		Ruppert et al. 1993	
		Aquatic inverts and debris/detritus		Brooks et al. 2000	San Juan River
	Size (mm) at age backcalculated	Algae, insects and crustaceans		Koster 1957	New Mexico
		25-30 (0), 30-40 (1), 40-50 (2), 50-60 (3) 37 (1), 59 (2)		Cross 1958 Quist and Guy 2001	Kansas Kansas
	Mortality (0-1)	~20% can't account for individuals spawned after june		Quist and Guy 2001	Kansas
	Mortality (1-2)	94%		Quist and Guy 2001	Kansas
	Mortality (2-3)	100%		Quist and Guy 2001	Kansas
	Age ORS				
	Adult RS				
	Pred Mrate ORS				
	Pred Mrate ARS				
	NMrate ORS				
	NMrate ARS				
	Thermal Maximum	37oc (27oC acclimation temp) 38.99oC (25oC acclimation temp)		Matthews and Hill 1977 Matthews and Maness 1979	Lab South Canadian River
Thermal Preferenda	30 23.3		Calhoun et al. 1982 Calhoun et al. 1982	unregulated river, texas regulated river, texas	

Red shiner bioenergetics information

Species	Parameter	Value	Source	Comments	
Red Shiner	CONSUMPTION			Duffy 1998	
	Equation	2			
	CA	0.149			
	CB	-0.242			
	CQ	2.4			
	CTO	24			
	CTM	30			
	CTL	*			
	CK1	*			
	CK4	*			
	RESPIRATION			Duffy 1998	
	Equation	2			
	RA	0.0096			
	RB	-0.041			
	RQ	2.6			
	RTO	28			
	RTM	33			
	RTL	*			
	RK1	*			
	RK4	*			
	ACT	1			
	BACT	*			
	SDA	0.172			
	EGESTION/EXCRETION			Duffy 1998	
	Equation	1			
	FA	0.1			
	FB	*			
	FG	*			
	UA	0.1			
	UB	*			
	UG	*			
	PREDATOR ENERGY DENSITY			Duffy 1998	
	Equation	1			
	Energy Density	980.8			
	Alpha 1	*			
	Beta 1	*			
	Cutoff	*			
	Alpha 2	*			
	Beta 2	*			
	MISCELLANEOUS				
	% spawning	0.08		based on values from Duffy 1998	
day of spawning	160 (June 9)		based from values used for Stella		
DIET					
Inverts	0.6		based on Tables 19-21 from Brooks et al. 2000		

Red shiner bioenergetics (continued)

Detritus	0.4	
RESPIRATION		Duffy 1998
Equation	2	
RA	0.0096	
RB	-0.041	
RQ	2.6	
RTO	28	
RTM	33	
RTL	*	
RK1	*	
RK4	*	
ACT	1	
BACT	*	
SDA	0.172	
EGESTION/EXCRETION		Duffy 1998
Equation	1	
FA	0.1	
FB	*	
FG	*	
UA	0.1	
UB	*	
UG	*	
PREDATOR ENERGY DENSITY		Duffy 1998
Equation	1	
Energy Density	980.8	
Alpha 1	*	
Beta 1	*	
Cutoff	*	
Alpha 2	*	
Beta 2	*	
MISCELLANEOUS		
% spawning	0.08	based on values from Duffy 1998
day of spawning	160 (June 9)	based from values used for Stella
DIET		
inverts	0.6	based on Tables 19-21 from Brooks et al. 2000
detritus	0.4	

Bluehead sucker Life History information.

Species	Parameter	Value	Source	Comments
Bluehead Sucker	Sex Ratio F:M	~1:2 (0.33)	Maddux and Kepner 1988, Otis 1994	
	Eggs per Female	20227	Smith 1996? cited in Valdez and Carothers 1998	
		8,500 (319 mm)	Smith 1966 cited in McAda 1977	Green River
		5,450 (319 mm) has regr. eq.	McAda 1977	Yampa River
		7,761 (319 mm) has regr. eq.	McAda 1977	Colorado River
		9,484 (385 mm)	MEC calcs from McAda 1977	
	Hatching Success			
	Spawning Time	April and May	Minckley 1991	Grand Canyon Region
		mid April through late May	Tyus and Karp 1990	Yampa, Green River
		September-October	Douglas and Douglas 2000	Havasu Creek
	Age of Maturity	all over 380 mm	McAda 1977	Upper basin
		>300mm (11.7in)	SJR Size Class Info	
	Max Life Span	20+ (396mm FL)	Scopettone 1988	Green River
		20+ (470mm)	Minckley 1991	Yampa River
	Diet	Organic debris (83%) and Inverts (16%)	Osmundson 1999	Colorado River
		Larval: 34% chironomidae, 39% organic, 13% inorganic	Childs et al. 1998	Little Colorado, shoreline habitats
		Aquatic inverts and debris/detritus	Brooks et al. 2000	San Juan River
		Aquatic inverts, cladophora, and debris/detritus	Carothers and Minckley 1981	Grand Canyon
	Size (mm) at age	94 (1), 132 (2), 167 (3), 195 (4), 220 (5), 244 (6), 307 (7), 323 (8)	Carothers and Minckley 1981	Grand Canyon
	October sampling	84 (0), 185 (1), 263 (2), 312 (3)	MEC calcs from Length-Freq Hist in Ryden ??	San Juan River
	60 mm (beg of Age 1)	Gido and Propst 1999	San Juan River	
Age 0B				
Age 1B				
Age 2B				
Adult B				
Pred Mrate 0B				
Pred Mrate JB				
Pred Mrate AB				
NMrate 0B				
NMrate 1B				
NMrate AB				

Flannelmouth sucker Life History information.

Species	Parameter	Value	Source	Comments
Flannelmouth Sucker	Sex Ratio F:M	~1:2 (0.33) 1:3.3 (0.23)	Weiss 1993, Otis 1994 McKinney et al. 1999	
	Eggs per Female	9,827 (450 mm) has regr. eq. 12,719 (450 mm) has regr. eq. 15,894 (450 mm) has regr. eq.	McAda 1977 McAda 1977 McAda 1977	Lee's Ferry Yampa River Gunnison River Colorado River
	Hatching Success			
	Spawning Time	May and early June May and June (6-12°C) March and April (7-19°C) March (7-15°C) mid-April through May	McAda and Wydoski 1985 McAda 1977 Weiss 1993 Otis 1994 Tyus and Karp 1990	Upper basin Upper basin Paria Creek Bright Angel Creek Yampa, Green River
	Age of Maturity	17-23°C by Age 7 >410mm (16 in) 300-400 mm	Carothers and Minckley 1981 McAda and Wydoski 1985 SJR Size Class Info Minckley and Holden 1980	Grand Canyon Upper basin General
	Max Life Span	most by 6, all by 7 at least 20 yrs 28+ (530mm FL) 35+ (590mm)	McAda 1977 McAda and Wydoski 1985 cited in Valdez and Carothers 1998 Scoppettone 1988 Minckley 1991	Upper basin Green River Green River
	Diet	Organic Debris (55%) and Inverts (40%) Larval: 34% chironomidae, 36% organic, 19% inorganic Larval: chironomids, cladocerans, copepods, similium Aquatic inverts and debris/detritus Aquatic inverts, cladophora and organic detritus	Osmundson 1999 Childs et al. 1998 Maddux et al. 1987 Brooks et al. 2000 Carothers and Minckley 1981 Douglas and Marsh 1998	Colorado River Little Colorado, shoreline habitat Grand Canyon San Juan River Grand Canyon Little Colorado River
	Survival Rates	rates broken down by age class (chart)	Carothers and Minckley 1981 Douglas and Marsh 1998	Grand Canyon Little Colorado River
	Size (mm) at age	122 (1), 189 (2), 261 (3), 322 (4), 358 (5), 396 (6) 420 (7), 449 (8), 478 (9), 466 (10) male 81 (1), 167 (2), 286 (3), 370 (4), 417 (5), 441 (6), 453 (7), 456 (8) female 77 (1), 144 (2), 273 (3), 370 (4), 430 (5), 465 (6), 479 (7), 485 (8)	Carothers and Minckley 1981 Carothers and Minckley 1981 McAda 1977 McAda 1977	Grand Canyon Grand Canyon Yampa, Green River Yampa, Green River
	July Sampling	105 (1), 166 (2), 295 (3), 319 (4), 356 (5), 362 (6)	McDonald and Dotson 1960	Colorado River
	Fall Sampling	85 (0), 237 (1), 338 (2), 389 (3) 60 mm (beg of Age 1)	MEC calcs from Length-Freq Hist in Ryden ?? Gido and Propst 1999	San Juan River San Juan River
	September	102 mm (age 0)	Gorman and VanHoosen 2000	Little Colorado River
	Age 0F			
	Age 1F			
	Age 2F			
	Age 3F			
	Age 4F			
	Age 5F			
	Age 6F			
	Adult F			
	Pred Mrate 0F			
	Pred Mrate JF			
	NMrate 0F			
	NMrate 1F			
	NMrate AF			

Channel catfish Life History information.

Species	Parameter	Value	Source	Comments
Channel Catfish	Sex Ratio F:M	1:1 (0.5)	Raibley and Jahn 1991	Mississippi R, MEC Calc
	Eggs per Female	~4,000/lb 7,759 (677-12,321) per kg body weight 17,624 eggs per female 6,088 ± 1,858 per lb body weight	Life History, Iowa Walser and Phelps 1993 Raibley and Jahn 1991 Helms 1975	For fish 1-4 lbs Mississippi R, MEC Calc Mississippi River
	Hatching Success			
	Spawning Time	July late July/August 21-29C 21-29C 24-28C (June/July) April-June	based on Montezuma Creek temperature logger based on Four Corners temperature logger Sublette 1990 Leichleitner 1992 cited in Valdez and Carothers 1998 Jester 1971 cited in Sublette 1990 Minckley 1973 cited in CC life history (□ussian□)	Temp >21C Temp >21C New Mexico Grand Canyon Elephant Butte Res. Arizona
	Age of Maturity	18.3°C 6 8-May 18 months 8 >300mm (11.7in) 3 (15 in)	Helms 1975 Life History, Iowa Scott and Crossman 1998 Scott and Crossman 1998 Sigler and Sigler 1987 cited in Valdez and Carothers 1988 SJR Size Class info Raibley and Jahn 1991	Mississippi River Typical Ponds in Texas Mississippi R, MEC Calc
	Max Life Span	22+ (756mm) 6-10 yrs usual 19+ (635 mm) 13+ (557 mm)	Tyus and Nikirk 1990, 24% of fish were >10 yrs 3 citations in Tyus and Nikirk 1990 Gerhardt and Hubert 1991 MEC ageing data	Yampa and Green Powder River San Juan River
	Diet	Aquatic inverts, □ussian olive and fish (13.5% in fish >450 mm) Aquatic inverts, cladophora, seeds, fish	Brooks et al. 2000 Carothers and Minckley 1981	San Juan River Grand Canyon
	Age 0CC			
	Age 1CC			
	Age 2CC			
	Age 3CC			
	Adult CC			
	Size (mm) at Age	59 (1), 148 (2), 220 (3), 295 (4), 398 (5), 444 (6) 95 (1), 181 (2), 254 (3), 332 (4), 407 (5), 478 (6), 528 (7), 587 (8) 79 (1), 164 (2), 219 (3), 247 (4), 280 (5), 304 (6), 340 (7), 373 (8) 63 (1), 116 (2), 165 (3), 202 (4), 234 (5), 260 (6), 283 (7), 305 (8) 322 (9), 352 (10) 71 (1), 175 (2), 236 (3), 305 (4), 386 (5), 467 (6), 531 (7) 388 (3), 411 (4), 475 (5), 497 (6), 559 (7), 604 (8), 603 (9), 604 (10) 238 (3), 291 (4), 341 (5), 386 (6), 434 (7), 469 (8), 504 (9), 554 (10) 101.6(1), 190.5(2), 271.8(3), 337.8(4), 327.7(5), 447(6) 143(1+), 229(2+), 259(3+), 298(4+), 334(5+), 364(6+), 420(8+), 557(13+)	Quist and Guy 1998 Quist and Guy 1998 Carothers and Minckley 1981 Tyus and Nikirk 1990 Tyus and Nikirk 1990 Kimsey et al. 1957 Raibley and Jahn 1991 Hubert 1999 Helms 1975 MEC ageing data Gido and Propst 1999 MEC calcs from Length-Freq Hist in Ryden 2005 Buentello et al. 2000 Andrews and Stickney 1972 Andrews et al. 1972	Kansas River, Fort Riley Kansas River, Lawrence Grand Canyon Yampa and Green Yampa and Green Colorado River Mississippi R, MEC Calc Av of 102 studies Mississippi River
	Fall sampling	70 mm (beg of Age 1)	Gido and Propst 1999	San Juan River
	Optimum temp (growth)	63 (0+), 138 (1+), 238 (2+) 28oC appx 30oC fingerlings 26-32oC	MEC calcs from Length-Freq Hist in Ryden 2005 Buentello et al. 2000 Andrews and Stickney 1972 Andrews et al. 1972	San Juan River
	Optimum temp (food conversion)	26.6-29.4°C	Shrable et al. 1969	lab

Channel catfish (continued)

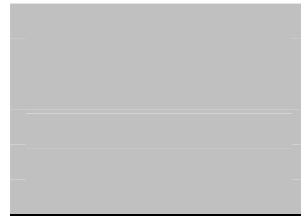

Pred Mrate OCC
Pred Mrate JCC
NMrate OCC
NMrate ICC
NMrate ACC

see Raibley and Jahn 1991

Speckled dace Life History information.

Species	Parameter	Value	Source	Comments
Speckled Dace	Sex Ratio F:M			
	Eggs per Female	329 (45-75 mm)	Johns 1963	Arizona
		5.7 per mm of body length	MEC cales from data in Johns 1963	
		314 (55 mm)	MEC cales for 55 mm individual using Johns 1963	
		932 (spring), 1440 (fall)	Carothers and Minckley 1981	Grand Canyon
	Hatching Success			
	Incubation time	6 days (appr. 18.3°C)	Sigler and Sigler 1987	Great Basin
	Spawning Time	April/May and August	Johns 1963	Arizona
		April and May	Minckley 1991	
		peak June and July (temp near 18.3°C)	Sigler and Sigler 1987	Great Basin
	Age of Maturity	2	Johns 1963	Arizona
		less than 1	Minckley 1991	
		>32mm	SJR Size Class Info	
		>40mm (Age 1)	Gido and Propst 1999	San Juan River
	Max Life Span	2-3 yrs	Minckley 1991	
		3+	from SJR SD lengths	
	Diet	Benthic inverts and organic debris	Carothers and Minckley 1981	Grand Canyon
		Benthic inverts (~85%) and debris/detritus (~15%)	Greger and Deacon 1988	Virgin River
	Larval, 48% chironomidae, 13% copepods, 14% organic	Childs et al. 1998	Little Colorado, shoreline habitats	
	Aquatic inverts and debris/detritus	Brooks et al. 2000	San Juan River	
Size (mm) at age	50 (1), 73 (2)	Carothers and Minckley 1981	Grand Canyon	
Age OSD				
Adult SD				
Pred Mrate OSD				
Pred Mrate ASD				
NMrate OSD				
NMrate ASD				
Thermal Maximum		32.4	Castleberry and Cech 1992	Klamath Basin

Speckled dace bioenergetics information.

Species	Parameter	Value	Source	Comments
Speckled Dace	CONSUMPTION			
	Equation	2	He 1986	
	CA	0.36		
	CB	-0.31		
	CQ	2.3		
	CTO	26		
	CTM	29		
	CTL	*		
	CK1	*		
	CK4	*		
	RESPIRATION			
	Equation	2	He 1986	
	RA	0.0148		
	RB	-0.2		
	RQ	2.1		
	RTO	29		
	RTM	32		
	RTL	*		
	RK1	*		
	RK4	*		
	ACT	1		
	BACT	*		
	SDA	0.15		
	EGESTION/EXCRETION			
	Equation	1	He 1986	
	FA	0.4		
	FB	*		
	FG	*		
	UA	0.1		
	UB	*		
	UG	*		
	PREDATOR ENERGY DENSITY			
	Equation	1	He 1986	
Energy Density	5006			
Alpha 1	*			
Beta 1	*			
Cutoff	*			
Alpha 2	*			
Beta 2	*			
MISCELLANEOUS				
% spawning	0.12	based on Platania 1995		
day of spawning	160 (June 9)	based from values used for Stella		

Razorback sucker Life History information.

Species	Parameter	Value	Source	Comments
Razorback Sucker	Sex Ratio F:M	1:1.61 (0.38)	Tyus 1987	Green River
		1:2.5 (0.24)	Tyus and Karp 1990	Yampa, Green River
		1:1.86 (0.46)	Bozek et al. 1984	Lake Mohave
	Eggs per Female	Mean 46,740 (n=10)	McAda and Wydoski 1980	Green River
		35 per g of body weight	MEC cales from data in McAda and Wydoski 1980	
		63,645 (49,838 eggs/kg)	Hamman 1985	Hatchery
		Mean 100,800 +/- 26,170 (n=5)	Minckley 1983	Lower basin
		Mean 1,812 +/- 90.5 eggs per cm SL	Minckley 1983	Lower basin
	Incubation Time	4-7 days (20-22°C)	Hamman 1985	Hatchery
		6-7 days (18-20°C), 11 days (15°C)	Snyder and Muth 1990	
	Hatching Success	5°C (0%), 10°C (0), 15°C (19), 20°C (35), 25°C (29), 30°C (0)	Marsh 1985	Laboratory
		12°C (0%)	Toney 1974 cited in Hamman 1985	Hatchery
	Spawning Time	late January through early April (>15C)	Minckley 1991	Lake Mohave
		mid February to early May	Holden et al. 1997	Lake Mead
		April 22 to June 15 (10-18°C)	Tyus 1987	Green River
		May 24 to June 17 (9-17°C)	Osmundson and Kaeding 1990 cited in USFWS 1997	Colorado River
		mid-late April through May (mean=14°C)	Tyus and Karp 1990	Yampa, Green River
	Age of Maturity	May	Modde et al. 2005	Green River
		begin at 2 (males), 3 (females)	Hamman 1985	Hatchery
	Max Life Span	mean 35 yrs old	McCarthy and Minckley 1987 cited in Minckley 1991	Lake Mohave
		mean 29 yrs old	W.L. Minckley 1989 cited in Minckley 1991	Green River
		44	McCarthy and Minckley 1987 cited in Minckley 1991	Lake Mohave
	Diet	Benthic inverts, mud and plant material	Vanicek 1967	Green River
	Thermal Preferendum	23-24°C	Bulkley et al. 1981	Hatchery fish
	Age 0F			
	Age 1F			
	Age 2F			
	Age 3F			
	Age 4F			
Age 5F				
Age 6F				
Adult F				
Pred Mrate 0F				
Pred Mrate JF				
NMrate 0F	97.50%	Modde and Wick 1996	Green River, backwaters	
Nmrate 1F	75%	Crowl and Bouwes 1998	Arbitrary	
			UCRB stocking plan	
Nmrate 2F	50%	Hudson 2001, and Nesler 2001	assumptions	
	60%	Crowl and Bouwes 1998	Arbitrary	
Nmrate 3F	40%	Hudson 2001, and Nesler 2001	UCRB stocking plan	
	45%	Crowl and Bouwes 1998	assumptions	
Nmrate AF	30%	Hudson 2001, and Nesler 2001	Arbitrary	
	29%	Modde et al. 1996	UCRB stocking plan	

Common carp Life History information.

Species	Parameter	Value	Source	Comments	
Common Carp	Sex Ratio F:M	1:1.8 (0.36)	Swee and McCrimmon 1966	Ontario	
	Eggs per Female	1328 per mm of body length 100-300,000 per kg body wt. 61,624 to 69,303 eggs/female	MEC calcs on data from Swee and McCrimmon 1966 Linhart et al. 1995 Carothers and Minckley 1981	Ontario Europe Grand Canyon	
	Hatching Success				
	Hatching Temps	20-25°C (21.7°C optimum)			
	Spawning Time	15-19.4°C (18.3°C optimum)	Bell 1990		
	Age of Maturity		17-23°C	Swee and McCrimmon 1966	Ontario
			late winter through August	Carothers and Minckley 1981	Grand Canyon
			2-4 males, 3-5 females	Carlander 1969	
			3-4 males, 4-5 females	Swee and McCrimmon 1966	Ontario
	Max Life Span		smallest female 381 mm, all by 432 mm	Swee and McCrimmon 1966	Ontario
			250 mm	SJR Size Class Info	
			12+	Lubinski et al. 1984 cited in Sublette 1990	Mississippi and Illinois Rivers
	Diet		captured up to 16	Swee and McCrimmon 1966	Ontario
			captured up to 12	Carothers and Minckley 1981	
			Organic debris and benthic inverts		
		as % volume	aquatic inverts (6.4%), terrestrial inverts (2.5%), fish (1.8%)	Eder and Carlson 1977	South Platte River
		as % volume	seeds (21.4%), aquatic plants (38.1%)	Eder and Carlson 1977	South Platte River
	Size (mm) at age Fall Sampling		dissolved and detritus (27.4%), sand (2.4%)	Eder and Carlson 1977	South Platte River
			Cladophora, inverts, organic detritus, plant seeds	Carothers and Minckley 1981	Grand Canyon
			207 (1), 264 (2), 312 (3), 354 (4), 388 (5), 416 (6), 432 (7), 466 (8)	Carothers and Minckley 1981	Grand Canyon
			88 (0), 213 (1+)	MEC calcs from Length-Freq Hist in Ryden 2003	San Juan River
			a lot of citations	Carlander 1969	
	Age 0F				
Age 1F					
Age 2F					
Age 3F					
Age 4F					
Age 5F					
Age 6F					
Adult F					
Pred Mrate 0F					
Pred Mrate 1F					
Nmrate 0F					
Nmrate 1F					
Nmrate AF					

Fathead minnow Life History information.

Species	Parameter	Value	Source	Comments
Fathead Minnow	Sex Ratio F:M	1:1.5 (May), 1:1.3 (June), 1:1.4 (July)	Payer and Scalet 1978	
	Eggs per Female	1:1	Carlson 1967	Skunk River, Des Moines River
		6800-10600 (16-26 spawns), mec calc ~414 per spawn	Gale and Buynak 1982	Artificial
		4306 (n=1)	Carothers and Minckley 1981	Grand Canyon
	Hatching Success	950 (n=10, 41-51 mm SL)	Isaak 1961 cited in Carlander 1969	
		1888 (n=4, 47-55 mm TL)	Carlson 1967	Skunk River, Des Moines River
		85 per spawn (19 per day)	Jensen et al. 2001	laboratory
	Spawning Time	water temp >15.6°C	Scott and Crossman 1998	
		when water temp >18°C til it drops below this temp	Dobie et al. 1956	
		last week of May (17.5-19.3C)	Held and Peterka 1974	North Dakota
		water temp >16C	Carlander 1969	
	Incubation	15.6-28.9C water temp range during spawning	Gale and Buynak 1982	laboratory
		May (17.8°C) to August	Sigler and Sigler 1987	Great Basin
		May (17.8oC)	Markus 1934	
		3 d (28-30°C), 4 d (23°C), 5 d (18°C)	personal comm.. Scott Kellman	laboratory
	Repeat Spawning	4-6 days (25°C)	Sigler and Sigler 1987	Great Basin
	Spawning Mort	Yes	Markus 1934	
		80-85%	Markus 1934	
	Reproductive Allocation	87%	Payer and Scalet 1978	
		13-17% of body mass	Carlson 1967	
Age of Maturity	380-680% of body volume	Gale and Buynak 1982		
	after 1 year	Scott and Crossman 1998	Canada	
	>30 mm (Age 1)	Gido and Propst 1999	San Juan River	
Max Life Span	individuals hatched early spawn same year	Markus 1934		
Diet	3	Markus 1934		
	crustacean zooplankton, ostracodes, and chironomid larvae	Held and Peterka 1974; Hambright and Hall 1992		
	and algae	Scott and Crossman 1998; Abrahams 1996	Canada	
	Aquatic inverts and debris/detritus	Brooks et al. 2000	San Juan River	
Caloric Density	no Larval fish (0.0% (n=95))	Brandenburg and Gido 1999	San Juan River	
	Aquatic inverts and organic detritus	Carothers and Minckley 1981	Grand Canyon	
	980.8 cal per g wet mass (mean)	Duffy 1998	South Dakota	
	835 to 945 cal per g	Chipps et al. 2000	Illinois	

Fathead minnow (continued)

	Size at age			
	Age 0F			
	Age 1F			
	Age 2F			
	Age 3F			
	Age 4F			
	Age 5F			
	Age 6F			
	Adult F			
	Pred Mrate 0F			
	Pred Mrate JF			
	NMrate 0F			
	NMrate 1F			
	NMrate AF			
	Thermal Maximum	33.1oC 34.4oC	Castleberry and Cech 1992 Heath et al. 1994	Klamath Basin

Invertebrate Life History information.

Species	Parameter	Value	Source	Comments	
Hydropsyche sp.	Sex Ratio F:M				
	Eggs per Female	397.5 (n=4) 840 (n=1)	Fremling 1960 Badcock 1953	H. orris, Mississippi R., Iowa H. angustipennis	
	Hatching Success				
	Hatching Time	Last wk June-September	D. Rees, pers comm		
	Survival	0.5% of eggs laid reach adult	Willis and Hendricks 1992		
	Caloric Density				
Chironomid C. riparius, Rees guess C. tentans, Rees guess	Sex Ratio F:M				
	Eggs per Female	1676 (n=10, range 1154-2014) max 410 average of all feeding rations (252 eggs) 400 max 700 max 208, from reg eq on 64 ind.	Hilsenhoff 1966 Pery et al. 2002 Pery et al. 2002 Postma et al. 1994 Sibley et al. 1997 Charles et al. 2004	Chironomus plumosus Chironomus riparius Chironomus riparius Chironomus riparius Chironomus tentans Chironomus riparius	
	Pupation	1 day @ 24oC, 6-10 days @ 10oC	Hilsenhoff 1966	Chironomus plumosus	
	Hatching Success				
	Hatching Time				
	Caloric Density				
	Feeding	0% (<5oC), 26% (8oC), 100% (10oC), Active (12oC)	Hilsenhoff 1966	Chironomus plumosus	
	Simulium S. vittatum Boris guess	Sex Ratio F:M			
		Eggs per Female	312 (n=3)	Davies and Peterson 1956	Simulium vittatum
		Pupation			
Hatching Success					
Hatching Time					
Caloric Density					
Feeding					

Fathead minnow bioenergetics

Species	Parameter	Value	Source	Comments
Fathead Minnow	CONSUMPTION		Duffy 1998	
	Equation	2		
	CA	0.149		
	CB	-0.242		
	CQ	2.4		
	CTO	24		
	CTM	30		
	CTL	*		
	CK1	*		
	CK4	*		
	RESPIRATION		Duffy 1998	
	Equation	2		
	RA	0.0096		
	RB	-0.041		
	RQ	2.6		
	RTO	28		
	RTM	33		
	RTL	*		
	RK1	*		
	RK4	*		
	ACT	1		
	BACT	*		
	SDA	0.172		
	EGESTION/EXCRETION		Duffy 1998	
	Equation	1		
	FA	0.1		
	FB	*		
	FG	*		
	UA	0.1		
	UB	*		
	UG	*		
	PREDATOR ENERGY DENSITY		Duffy 1998	
	Equation	1		
Energy Density	980.8			
Alpha 1	*			
Beta 1	*			
Cutoff	*			
Beta 2	*			

Fathead minnow bioenergetics (continued)

	MISCELLANEOUS		
	% spawning	0.08	based on values from Duffy 1998
	day of spawning	175 (June 24)	based from values used for Stella
	DIET		
	inverts	0.15	based on Tables 19-21 from Brooks et al.
	detritus	0.85	2000

General information for Bioenergetics

Species	Parameter	Value	Source	Comments
Detritus	Energy content	419 J g ⁻¹	Ahlgren 1990	
	Indigestibility proportion	0.4		
Zooplankton	Energy content	2637 J g ⁻¹	Cummins and Wuycheck 1971 citation in Horppila 1999	
	Indigestibility proportion	0.2		
Invertebrates	Energy content	3349 J g ⁻¹	Cummins and Wuycheck 1971 citation in Horppila 1999	
	Indigestibility proportion	0.2		
Plant Material	Energy content	1047 J g ⁻¹	Cummins and Wuycheck 1971 citation in Horppila 1999	
	Indigestibility proportion	0.5		
Fish	Energy content	4186 J g ⁻¹	Wisc Model	
	Cyplut	Energy content	4923.2 Calories/g dry mass	
	Pimpro	Energy content	4286.1 Calories/g dry mass	
	Rhiosc	Energy content	5576.9 Calories/g dry mass	
	Catdis	Energy content	5564.6 Calories/g dry mass	
	Catlat	Energy content	4308.7 Calories/g dry mass	
	Micsal	Energy content	4196.4 Calories/g dry mass	
Invertebrates				
	Chironomidae	Energy content	3601.6 Calories/g dry mass	
	Ephemeroptera	Energy content	4480.7 Calories/g dry mass	
	Trichoptera	Energy content	4790.2 Calories/g dry mass	
	Odonata	Energy content	4732.7 Calories/g dry mass	
Filamentous Algae	Energy content	2828.3 Calories/g dry mass		

Bioenergetics

Consumption

Cmax	$0.278W^{-0.197}$		Petersen and Ward 1999
$\frac{p}{F(T)}$	$V^X * e^{(X(1-V))}$		Kitchell et al. 1977 (eq. 2 from Hanson 1997)
	where		
	V=	$(CTM-T)/(CTM-CTO)$	
	X=	$(Z^2(1+(1+40/Y)^{0.5})^2)/400$	
	Z=	$LN(CQ)(CTM-CTO)$	
	Y=	$LN(CQ)(CTM-CTO+2)$	
	where		
	CTO=	25.4	Bulkley et al. 1982
	CTM=	35	Estimate
	CQ=	0.59	Bevelhimer et al. 1985
	CA	0.2045	Bevelhimer et al. 1985
	CB	-0.18	Bevelhimer et al. 1985
	CQ	0.59	Bevelhimer et al. 1985
	CTO	24	Bevelhimer et al. 1985
	CTM	34	Bevelhimer et al. 1985

Respiration

R	$R_s * ACT$		Petersen and Ward 1999 (eq. 1 from Hanson 1997)
	where		
	$R_s = aW^b * e^{tT}$		
	where		
	t (RQ)=	0.105	Cech et al. 1994
	a (RA)=	0.00165	Cech et al. 1994
	b (RB)=	-0.285	Cech et al. 1994
	$ACT = e^{u\psi}$		
	where		
	u (RTO)=	0.1222	Bevelhimer et al. 1985
	ψ (RK1)=	5	Petersen and Ward 1999
SDA=		0.163	Rice et al. 1983
	RA	0.00246	Bevelhimer et al. 1985
	RB	-0.18	Bevelhimer et al. 1985
	RQ	0.055	Bevelhimer et al. 1985
	RTO	0.1222	Bevelhimer et al. 1985
	RK1	1	Bevelhimer et al. 1985
	ACT	1	Bevelhimer et al. 1985
	SDA	0.14	Bevelhimer et al. 1985

Bioenergetics (continued)

Egestion and Excretion

Egestion
Excretion

$F = FA * C$
 $U = UA * (C - F)$
where

$FA = 0.2$ Bevelhimer et al. 1985
 $UA = 0.07$ Bevelhimer et al. 1985

Energy Density

Prey	4310 j/g	Petersen and Ward 1999
Northern Pikeminnow	6703 j/g	Petersen and Ward 1999
Northern Pike	3600 j/g	Bevelhimer et al. 1985

Spawning Loss

Male	6.30%	Petersen and Ward 1999
Female	1.90%	Petersen and Ward 1999

Spawning periodicity

Species	Beg	End	Spawning		Duration	Adult Age	Life Span
			Weeks for Stella	Incubation			
Colorado pikeminnow ¹	25-Jun	29-Jul	26-30	6 days	34 days	8	
Bluehead sucker	30-Apr	3-Jun	18-22			3	
Fathead minnow ²	25-Jun	30-Sep	26-39	3-5 d (18-30C)		1	
Flannelmouth sucker ³	30-Apr	10-Jun	18-23			6	
Razorback sucker ⁴	30-Apr	17-Jun	18-24				
Channel catfish ⁵	23-Jul	26-Aug	30-34			6	
Red shiner	10-Jun	9-Sep	23-36				
Common Carp	25-Jun	5-Aug	26-31				
Speckled Dace	10-Jun	9-Sep	23-36				

- 1)
- 2) Weeks were based on a spawning initiation water temp of 16°C and temp data for WY1995 from the four-corners thermograph
- 3) Weeks were based upon McAda 1977 and McAda and Wydoski 1985
- 4)
- 5) Weeks were based on spawning temperature requirements and temp data from four-corners thermograph as well as Platania larval capture data

Bioenergetic Input

Parameter	Flanny	Blue	Carp	Catfish	Razorback	Pikeminnow	Wisconsin Model book values										
							Bluegill	YP	Dace	YOY Yp	Tilapia	SB	FH	CP	NP	musky	Suck
Consumption Equation	2	2	2	2	2	1											
CB	-0.301	-0.301	-0.301	-0.274	-0.301	-0.18	-0.274	-0.27	-0.31	-0.42	-0.36	-0.31	-0.242	-0.18	-0.197	-0.18	-0.301
CA	0.1495	0.1495	0.1495	0.182	0.1495	0.2215	0.182	0.25	0.36	0.51	0.15	0.25	0.149	0.2045	0.278	0.2215	0.1495
CTO	25g	22f	27c	28a	25e	26											
CTM	31g	28f	35d	36b	31e	34											
CQ	2.2	2.2	2.15	2.15	2.2	2.53											
Respiration Equation	2	2	2	2	2	1											
RA	0.0214	0.0214	0.0214	0.0154	0.0214	0.00246											
RB	-0.274	-0.274	-0.274	-0.2	-0.274	-0.18											
RQ	2.2	2.2	2.2	2.1	2.2	0.055											
RTO	31	28	35	36	31	0.1222											
RTM	34	31	38	39	34												
SDA	0.136	0.136	0.136	0.172	0.136	0.14											

Note: Flannelmouth, Bluehead, Razorback, and Carp are an average of Bluegill and Tilapia

a: Buentello?? 2000

b: Jobling
1981

c: Pitt et al. 1956 cited in Carlander 1969 (P103)

d: Black 1953 cited in Carlander 1969 (B200)

e: Bulkley et al. 1982

f: professional judgement

g: based on razorback numbers

Bioenergetic Input (continued)

Weight	Cmax Calculations										
	Bluegill	YP	Dace	YOY Yp	Tilapia	SB	FH	NP	pikm	musky	Suck
1	0.182	0.25	0.36	0.51	0.15	0.25	0.149	0.2045	0.278	0.2215	0.1495
3	0.134691	0.185831	0.256091	0.321499	0.101001	0.177841	0.114215	0.167808	0.223899	0.181757	0.107406
7	0.106786	0.14783	0.196935	0.225231	0.074449	0.13676	0.093041	0.144071	0.189479	0.156047	0.083227
13	0.090126	0.125076	0.162547	0.173666	0.059576	0.11288	0.080096	0.128879	0.167725	0.139593	0.069079
20	0.080092	0.111343	0.142227	0.144923	0.051018	0.098769	0.072167	0.119264	0.154078	0.129178	0.060678
25	0.075342	0.104833	0.132721	0.131958	0.04708	0.092168	0.068373	0.114568	0.147452	0.124092	0.056736
30	0.07167	0.099797	0.125428	0.12223	0.044089	0.087103	0.065422	0.110869	0.14225	0.120086	0.053707
35	0.068706	0.095729	0.119575	0.114568	0.041709	0.083038	0.063026	0.107835	0.137995	0.1168	0.051272
40	0.066238	0.092339	0.114727	0.108319	0.039751	0.079671	0.061022	0.105274	0.134412	0.114026	0.049252
45	0.064134	0.089448	0.110613	0.103091	0.038101	0.076815	0.059307	0.103066	0.131329	0.111634	0.047536
50	0.062309	0.08694	0.107059	0.098629	0.036683	0.074346	0.057814	0.10113	0.128632	0.109537	0.046052
200	0.042618	0.059795	0.06966	0.055098	0.02227	0.048375	0.041337	0.078797	0.097891	0.085347	0.030341

APPENDIX C – References

- Abrahams, M.V. 1995. The interaction between antipredator behaviour and antipredator morphology: experiments with fathead minnows and brook sticklebacks. *Can. J. Zool.* 73:2209-2215.
- Abrahams, M.V. 1996. Interaction between young-of-the-year fathead minnows and brook sticklebacks: effect on growth and diet selection. *Transactions of the American Fisheries Society* 125:480-485.
- Ahlgren, M.O., 1990. Nutritional significance of facultative detritivory to the juvenile white sucker (*Catostomus commersoni*). *Canadian Journal of Fisheries and Aquatic Science* 47:49-54.
- Andrews, J.W., and R.R. Stickney. 1972. Interactions of feeding rates and environmental temperature on growth, food conversion and body composition of channel catfish. *Transactions of the American Fisheries Society* 101:94-99.
- Andrews, J.W., L.H. Knight, and T. Murai. 1972. Temperature requirements for high density rearing of channel catfish from fingerling to market size. *Progressive Fish-Culturist* 34:240-241.
- Archer, E. and T.A. Crowl. 2000. Abundance of age-0 native fish species and nursery habitat quality and availability in the San Juan River, New Mexico, Colorado, and Utah. San Juan River Basin Recovery Implementation Program.
- Badcock, R.M. 1953. Observation of oviposition under water of the aerial insect *Hydropsyche angustipennis* (Curtis) (Trichoptera). *Hydrobiologia* 5:222-225.
- Baltz, D.M., P.B. Moyle, and N.J. Knight. 1982. Competitive interactions between benthic stream fishes, riffle sculpin, *Cottus gulosus*, and speckled dace, *Rhinichthys osculus*. *Can. J. Fish. Aquat. Sci.* 39:1502-1511.
- Bell, M.C. 1990. Fisheries handbook of engineering requirements and biological criteria. Chapter 11. Fish Passage Development and Evaluation Program. U.S. Army Corp of Engineers, North Pacific Division, Portland, OR.
- Bestgen, K.R., and M.A. Williams. 1994. Effects of fluctuating and constant temperatures on early development and survival of Colorado squawfish. *Transactions of the American Fisheries Society* 123:574-579.
- Bestgen, K.R., and J.M. Bundy. 1998. Environmental factors affect daily increment deposition and otolith growth in young Colorado squawfish. *Transactions of the American Fisheries Society* 127:105-117.
- Bestgen, K.R., R.T. Muth, and M.A. Trammell. 1998. Downstream transport of Colorado squawfish larvae in the Green River drainage: temporal and spatial

variation in abundance and relationships with juvenile recruitment. Final Report. Colorado River Recovery Implementation Program project number 32.

- Bezzerrides, N. and K. Bestgen. 2002. Final report – Status review of roundtail chub *Gila robusta*, flannelmouth sucker *Catostomus latipinnis*, and bluehead sucker *Catostomus discobolus* in the Colorado River Basin. Colorado State University Larval Fish Lab Contribution 118.
- Bondari, K. 1990. Reproduction and genetics of the channel catfish (*Ictalurus punctatus*). Reviews in Aquatic Sciences Vol. 2, Issues 3 and 4, 357-374.
- Bosworth, B.G., W.R. Wolters, D.J. Wise, and M.H. Li. 1998. Growth, feed conversion, fillet proximate composition and resistance to *Edwardsiella ictaluri* of channel catfish, *Ictalurus punctatus* (Rafinesque) blue catfish, *Ictalurus furcatus* (Lesueur), and their reciprocal F1 hybrids fed 25% and 45% protein diets. Aquaculture Research 29:251-257.
- Bozek, M.A., L.J. Paulson, and J.E. Deacon. 1984. Factors affecting reproductive success of bonytail chubs and razorback suckers in Lake Mohave. Environmental Research Center, University of Nevada, Las Vegas, Las Vegas, NV.
- Brandenburg, W.H. and K.B. Gido. 1999. Predation by nonnative fish on native fishes in the San Juan River, New Mexico and Utah. Southwestern Naturalist 44(3):392-394.
- Brazo, D.C., C.R. Liston, and R.C. Anderson. 1978. Life history of the longnose dace, *Rhinichthys cataractae*, in the surge zone of eastern Lake Michigan near Ludington, Michigan. Transactions of the American Fisheries Society 107(4):550-556.
- Brown, C.R. and J.N. Cameron. 1991. The induction of specific dynamic action in channel catfish by infusion of essential amino acids. Physiological Zoology 64(1):276-297.
- Brown, M.L., F. Jaramillo, Jr., D.M. Gatlin III, and B.R. Murphy. 1995. A revised standard weight (*Ws*) equation for channel catfish. Journal of Freshwater Ecology 10(3):295-302.
- Brown, P., C. Green, K.P. Sivakumaran, D. Stoessel, and A. Giles. 2004. Validating otolith annuli for annual age determination of common carp. Transactions of the American Fisheries Society 133:190-196.
- Brooks, J.E., M.J. Buntjer, and J.R. Smith. 2000. Non-native species interactions: Management implications to aid in recovery of the Colorado pikeminnow (*Ptychocheilus lucius*) and razorback sucker (*Xyrauchen texanus*) in the San Juan River, CO-NM-UT. Final Report. U.S. Fish and Wildlife Service, Albuquerque, NM.

- Bulkley, R.V., C.R. Berry, R. Pimentel, T. Black. 1981. Tolerance and preferences of Colorado River endangered fishes to selected habitat parameters. Utah Cooperative Fishery Research Unit Report No. 5, Utah State University, Logan, Utah.
- Bulkley, R.V. and R. Pimentel. 1983. Temperature preference and avoidance by adult Razorback Suckers. Transactions of the American Fisheries Society 112:601-607.
- Buentello, J.A., D.M. Gatlin III, and W.H. Neill. 2000. Effects of water temperature and dissolved oxygen on daily feed consumption, feed utilization and growth of channel catfish (*Ictalurus punctatus*). Aquaculture 182:339-352.
- Cabecinha, E., R. Cortes, and J.A. Cabral. 2003. Performance of a stochastic-dynamic modeling methodology for running waters ecological assessment. Ecological Modelling 175 (2004) 303-317.
- Calhoun, S.W., E.G. Zimmerman, and T.L. Beiting. 1982. Stream regulation alters acute temperature preference of red shiners, *Notropis lutrensis*. Canadian Journal of Fisheries and Aquatic Sciences 39:360-363.
- Carbinale, B.J., E.R. Gelmann, and M.A. Palmer. 2004. Net spinning caddisflies as stream ecosystem engineers: the influence of *Hydropsyche* on benthic substrate stability. Functional Ecology 2004 18, 381-387.
- Carlander, K.D. 1969. Handbook of freshwater fishery biology, Vol. 1. Iowa State University Press, Ames, IA.
- Carlson, D.R. 1967. Fathead minnow, *Pimephales promelas* Rafinesque, in the Des Moines river, Boone County, Iowa, and the Skunk River drainage, Hamilton and Story counties, Iowa. Iowa State Journal of Science 41:363-374.
- Carothers, S.W., and C.O. Minckley. 1981. A survey of the fishes, aquatic invertebrates, and aquatic plants of the Colorado River and selected tributaries from Lee's Ferry to Separation Rapids. Final report prepared for Water and Power Resources Service, Boulder City, NV. Contract no. 7-07-30-X0026. 401 pp.
- Castleberry, D.T., and J.J. Cech, Jr. 1992. Critical thermal maxima and oxygen minima of five fishes from the Upper Klamath Basin. California Fish and Game 78(4):145-152.
- Cech, J.J. Jr., D.T. Castleberry, and T.E. Hopkins. 1994. Temperature and CO₂ effects on blood O₂ equilibria in northern squawfish, *Ptychocheilus oregonensis*. Can. J. Fish. Aquat. Sci. 51:13-19.

- Cech, J.J. Jr., D.T. Castleberry, T.E. Hopkins, and J.H. Petersen. 1994. Northern squawfish, *Ptychocheilus oregonensis*, O₂ consumption rate and respiration model: effects of temperature and body size. *Can. J. Fish. Aquat. Sci.* 51:8-12.
- Charles, S., M. Ferreol, A. Chaumot, A.R.R. Péry. 2004. Food availability effect on population dynamics of the midge *Chironomus riparius*: a Leslie modeling approach. *Ecological Modelling* 175:217-229.
- Childs, M.R., R.W. Clarkson, and A.T. Robinson. 1998. Resource use by larval and early juvenile native fishes in the Little Colorado River, Grand Canyon, Arizona. *Transactions of the American Fisheries Society* 127:620-629.
- Chippo, S.R., L.M. Einfalt, and D.H. Wahl. 2000. Growth and food consumption by tiger muskellunge: Effects of temperature and ration level on bioenergetic model predictions. *Transactions of the American Fisheries Society* 129:186-193.
- Costanza, R. and S. Gottlieb. 1998. Modelling ecological and economic systems with STELLA: Part II. *Ecological Modelling* 112 (1998) 81-84.
- Crowl, T.A., and N.W. Bouwes. 1998. A population model for four endangered Colorado River fishes. Ecology Center, Utah State University, Logan, UT.
- Cummins, W.C., and J.C. Wuycheck. 1971. Caloric equivalents for investigations in ecological research. *Mitt. int. Ver. Limnol.* 18:1-158.
- Davies, D.M., and B.V. Peterson. 1956. Observations on the mating, feeding, ovarian development, and oviposition of adult black flies (Simuliidae, Diptera). *Canadian Journal of Zoology* 34:615-655.
- Dobie, J., Meehean, O.L., Snieszko, S.F., and Washburn, G.N. 1956. Raising bait fishes. *U.S. Fish and Wildlife Service Circ.* 35.
- Douglas, M.R., and M.E. Douglas. 2000. Late season reproduction by big-river catostomidae in Grand Canyon (Arizona). *Copeia* 2000(1):238-244.
- Douglas, M.E., and P.C. Marsh. 1998. Population and survival estimates of *Catostomus latipinnis* in Northern Grand Canyon, with distribution and abundance of hybrids with *Xyrauchen texanus*. *Copeia* 1998(4):915-925.
- Dudley, R.K. and S.P. Platania. 2000. Draft Report – Downstream transport rates of passively drifting particles and larval Colorado pikeminnow in the San Juan River in 1999. Division of Fishes, University of New Mexico.
- Dudley, R.K. and S.P. Platania. 2000. Draft Report – Downstream transport rates of passively drifting particles in the San Juan River in 1998. Division of Fishes, University of New Mexico.

- Durham, B.W. and G.R. Wilde. 2005. Relationship between hatch date and first-summer growth of five species of prairie-stream cyprinids. *Environmental Biology of Fishes* (2005) 72:45-54.
- Duffy, W.G. 1998. Population dynamics, production, and prey consumption of fathead minnows (*Pimephales promelas*) in prairie wetlands: a bioenergetics approach. *Canadian Journal of Fisheries and Aquatic Sciences* 54:15-27.
- Eder, S., and C.A. Carlson. 1977. Food habits of carp and white suckers in the South Platte and St. Vrain Rivers and Goosequill Pond, Weld County, Colorado. *Transactions of the American Fisheries Society* 106(4):339-346.
- Farringer III, R.T., A.A. Echelle, and S.F. Lehtinen. 1979. Reproductive cycle of red shiner, *Notropis lutrensis*, in Central Texas and South Central Oklahoma. *Transactions of the American Fisheries Society* 108:271-276.
- Franssen, N.R., K.B. Gido, and D.L. Propst. 2004. Trophic relationships among Colorado pikeminnow (*Ptychocheilus lucius*) and its prey in the San Juan River. Annual Report.
- Fremling, C.R. 1960. Biology and possible control of nuisance caddisflies of the upper Mississippi River. Research Bulletin 483, Agricultural and Home Economics Experiment Station. Ames, IA.
- Gale, W.F. 1986. Indeterminate fecundity and spawning behavior of captive red shiners--fractional, crevice spawners. *Transactions of the American Fisheries Society* 115:429-437.
- Gale, W.F., and G.L. Buynak. 1982. Fecundity and spawning frequency of the fathead minnow--a fractional spawner. *Transactions of the American Fisheries Society* 111:35-40.
- Gauthier, S. and D. Boisclair. 1997. The energetic implications of diel onshore-offshore migration by dace (*Phoxinus eos* x*P. Neogaeus*) in a small oligotrophic lake. *Can. J. Fish. Aquat. Sci.* 54:1996-2006.
- Gerhardt, D.R., and W.A. Hubert. 1991. Population dynamics of a lightly exploited channel catfish stock in the Powder River system, Wyoming-Montana. *North American Journal of Fisheries Management* 11:200-205.
- Gido, K.B. and W.J. Matthews. 2001. Ecosystem effects of water column minnows in experimental streams. *Oecologia* 126:247-253.

- Gido, K.B., J.F. Schaefer, K. Work, P.W. Lienesch, E. Marsh-Matthews, and W.J. Matthews. 1999. Effects of red shiner (*Cyprinella lutrensis*) on Red River pupfish (*Cyprinodon rubrofluviatilis*). *The Southwestern Naturalist* 44(3):287-295.
- Gido, K.B., and D.L. Propst. 1999. Habitat use and association of native and nonnative fishes in the San Juan River, New Mexico and Utah. *Copeia* 1999:321-332.
- Gilpin, M. 1993. A population viability analysis of the Colorado squawfish in the Upper Colorado River Basin: A report to the United States Fish and Wildlife Service, Denver, CO.
- Gorman, O.T. 1994. Habitat use by humpback chub, *Gila cypha*, in the Little Colorado River and other tributaries of the Colorado River. Volume 1. Glen Canyon Environmental Studies Phase II Final Report. U.S. Fish and Wildlife Service, Flagstaff, Arizona.
- Gorman, O.T., and R.R. VanHoosen. 2000. Experimental growth of four native Colorado River fishes at temperatures of 12, 18, and 24°C. Draft Final Report, U.S. Geological Survey, Grand Canyon Monitoring and Research Center. Flagstaff, AZ.
- Gray, R.H. and D.D. Dauble. 2001. Some life history characteristics of cyprinids in the Hanford Reach, Mid-Columbia River. *Northwest Science*, Vol. 75, No. 2, 122-136.
- Greger, P.D., and J.E. Deacon. 1988. Food partitioning among fishes of the Virgin River. *Copeia* 1988:314-323.
- Hambright, K.D. and R.O. Hall. 1992. Differential zooplankton feeding behaviors, selectivities, and community impacts of two planktivorous fishes. *Environmental Biology of Fishes* 35:401-411.
- Haines, G.B., and T. Modde. 1996. Evaluation of marking techniques to estimate population size and first-year survival of Colorado squawfish. *North American Journal of Fisheries Management* 16:905-918.
- Hamman, R.L. 1981. Spawning and culture of Colorado squawfish in raceways. *Progressive Fish-Culturist* 43:173-177.
- Hamman, R.L. 1985. Induced spawning of hatchery-reared razorback sucker. *Progressive Fish-Culturist* 47(3):187-189.
- Hamman, R.L. 1986. Induced spawning of hatchery-reared Colorado squawfish. *Progressive Fish-Culturist* 48:72-74.

- Hamman, R.L. 1989. Survival of Colorado squawfish in earthen ponds. *Progressive Fish-Culturist* 51:27-29.
- Hamman, R.L. 2003. Colorado pikeminnow fingerling production, San Juan River, FY-2002. Dexter National Fish Hatchery and Technology Center, Dexter, NM. 2 pp.
- Harvey, B.C., J.L. White, and R.J. Nakamoto. 2004. An emergent multiple predator effect may enhance biotic resistance in a stream fish assemblage. *Ecology* 85(1):127-133.
- Hatch, U. and T. Hanson. 1995. The economic impact of feeding restrictions on US catfish, *Ictalurus punctatus* (Rafinesque), aquaculture operations. *Aquaculture Research* 26, 687-699.
- Hawkins, J.A. 1992. Age and growth of Colorado squawfish from the Upper Colorado River Basin, 1978-1990. Master's Thesis. Colorado State University, Fort Collins, CO.
- Heath, S., W.A. Bennet, J. Kennedy, and T.L. Beitinger. 1994. Heat and cold tolerance of the fathead minnow, *Pimephales promelas*, exposed to the synthetic pyrethroid Cyfluthrin. *Canadian Journal of Fisheries and Aquatic Sciences* 51:437-440.
- Held, J.W., and Peterka, J.J. 1974. Age, growth, and food habitats of the fathead minnow, *Pimephales promelas*, in North Dakota saline lakes. *Transactions of the American Fisheries Society* 103:743-756.
- Helms, D.R. 1975. Variations in the abundance of channel catfish year classes in the upper Mississippi River and causative factors. Fisheries Section, University of Wisconsin-Milwaukee, Technical Series 75-1.
- Hambright, K.D. and Hall, R.O. 1992. Differential zooplankton feeding behaviors, selectivities, and community impacts of two planktivorous fishes. *Environmental Biology of Fishes* 35:401-411.
- Hilsenhoff, W.L. 1966. The biology of *Chironomus plumosus* (Diptera: Chironomidae) in Lake Winnebago, Wisconsin. *Annals of the Entomological Society of America* 59(3):465-473.
- Holden, P.B., P.D. Abate, and J.B. Ruppert. 1997. Razorback sucker studies on Lake Mead, Nevada, 1996-1997 annual report, PR-578-1. Submitted to Department of Resources, Southern Nevada Water Authority, Las Vegas, NV. 49 pp.

- Horppila, J. 1999. Diel changes in diet composition of an omnivorous cyprinid – a possible source of error in estimating food consumption. *Hydrobiologia* 400:33-39.
- Hubert, W.A. 1999. Standards for assessment of age and growth data for channel catfish. *Journal of Freshwater Ecology* 14(3):313-326.
- Hudson, J.M. 2001. State of Utah stocking plan for endangered fish species of the upper Colorado River basin: Revised plan. Publication Number 01-22. Utah Division of Wildlife Resources, Salt Lake City, UT. 14 pp.
- Iowa, state of. Channel catfish. *Fishes of Iowa*.
- Isaac, D. 1961. The ecological life history of the fathead minnow, *Pimephales promelas* (Rafinesque). Doctoral Dissertation, University of Minnesota Library.
- Jarboe, H.H. 1995. Diel dissolved oxygen consumption and total ammonia nitrogen production by fingerling channel catfish following feeding at different times. *The Progressive Fish-Culturist* 57:156-160.
- Jensen, K.M., J.J. Korte, M.D. Kahl, M.S. Pasha, and G.T. Ankley. 2001. Aspects of basic reproductive biology and endocrinology in the fathead minnow (*Pimephales promelas*). *Comparative Biochemistry and Physiology Part C*, 128(2001):127-141.
- Jobling, M. 1981. Temperature tolerance and the final preferendum-rapid methods for the assessment of optimum growth temperatures. *J. Fish Biol.* (1981)19, 439-455.
- John, K.R. 1963. The effect of torrential rains on the reproductive cycle of *Rhinichthys osculus* in the Chiricahua Mountains, Arizona. *Copeia* 1963:286-291.
- Johnson, J.E., M.G. Pardew, and M.M. Lyttle. 1993. Predator recognition and avoidance by larval razorback sucker and northern hog sucker. *Transactions of the American Fisheries Society* 122:1129-1145.
- Jonez, A., and R.C. Sumner. 1954. Lakes Mead and Mohave investigations: A comparative study of an established reservoir as related to a newly created impoundment. Federal Aid to Fisheries Restoration Project Completion Report, F-1-R, Nevada Fish and Game Commission, Reno, NV. 186 pp.
- Kaya, C.M. 1991. Laboratory spawning and rearing of speckled dace. *The Progressive Fish-Culturist* 53:259-260.
- Killian, H.S. 2001. Winter feeding channel catfish. Aquaculture/Fisheries Center, University of Arkansas at Pine Bluff.

- Klar, G.T., N.C. Parker, and C.A. Goudie. 1988. Comparison of growth among families of channel catfish. *The Progressive Fish-Culturist* 50:173-178.
- Kimsey, J.B., R.H. Hagy, and G.W. McCammon. 1957. Progress report on the Mississippi threadfin shad, *Dorosoma petenensis atchaflayae*, in the Colorado River for 1956. California Inland Fisheries Administrative Report 57-23. 48 pp.
- Lechleitner, R.A. 1992. Literature review of the thermal requirements and tolerances of organisms below Glen Canyon Dam. Draft document submitted to Glen Canyon Environmental Studies, Bureau of Reclamation, Flagstaff, AZ.
- Linhart, O., S. Kudo, R. Billard, V. Slechta, and E.V. Mikodina. 1995. Morphology, composition, and fertilization of carp eggs: a review. *Aquaculture* 129(1995):75-93.
- Lubinski, K.S., S.D. Jackson, and B.N. Hartsfield. 1984. Age structure and analysis of carp populations in the Mississippi and Illinois River. Illinois Natural History Survey, Aquatic Section Report. 1984(9) 29 pp.
- Maddux, H.R., and W.G. Kepner. 1988. Spawning of bluehead sucker in Kanab Creek, Arizona. *The Southwestern Naturalist* 33:361.
- Marsh, P.C. 1985. Effect of incubation temperature on survival of embryos of native Colorado River fishes. *The Southwestern Naturalist* 30(1):129-140.
- Marsh-Matthews, E., W.J. Matthews, K.B. Gido, and R.L. Marsh. 2002. Reproduction by young-of-year red shiner (*Cyprinella lutrensis*) and its implications for invasion success. *Southwestern Naturalist* 47(4):605-610.
- Marzolf, R.C. 1955. Use of pectoral spines and vertebrae for determining age and rate of growth of the channel catfish. *Journal of Wildlife Management* 19(2)243-249.
- Masser, M.P., W.E. Grant, W.H. Neill, and E.H. Robinson. 1991. A simulation model representing effects on dietary energy/protein ratio and water temperature on growth of channel catfish (*Ictalurus punctatus*). *Ecological Modelling* 53:17-35.
- Matthews, W.J., K.B. Gido, and E. Marsh-Matthews. 2001. Density-dependent overwinter survival and growth of red shiners from a southwestern river. *Transactions of the American Fisheries Society* 130:478-488.
- Matthews, W.J., and L.G. Hill. 1977. Tolerance of the red shiner, *Notropis lutrensis* (Cyprinidae) to environmental parameters. *Southwestern Naturalist* 22(1):89-98.

- Matthews, W.J., and J.D. Maness. 1979. Critical thermal maxima, oxygen tolerances and success of cyprinid fishes in a Southwestern river. *American Midland Naturalist* 102:374-377.
- Markus, H.C. 1934. Life history of the blackhead minnow (*Pimephales promelas*). *Copeia* 1934:116-122.
- Marsh, P.C. 1985. Effect of incubation temperature on survival of embryos of native Colorado River fishes. *The Southwestern Naturalist* 30(1):129-140.
- McAda, C.W. 1977. Aspects of the life history of three catostomids native to the upper Colorado River basin. Master's Thesis. Utah State University, Logan, UT.
- McAda, C.W., and R.S. Wydoski. 1980. The razorback sucker, *Xyrauchen texanus*, in the upper Colorado River basin. U.S. Fish and Wildlife Service Technical Paper 99:1-15.
- McAda, C.W., and R.S. Wydoski. 1985. Growth and reproduction of the flannelmouth sucker, *Catostomus latipinnis*, in the upper Colorado River basin, 1975-76. *Great Basin Naturalist* 45:281-286.
- McCarthy, M.S., and W.L. Minckley. 1987. Age estimation for razorback sucker from Lake Mohave, Arizona, and Nevada. *Journal of Arizona-Nevada Academy Sciences* 21:87-97.
- McCrimmon, H.R. 1968. Carp in Canada. Fisheries Research Board of Canada. Bulletin 165.
- McDonald, D.B., and P.A. Dotson. 1960. Fishery investigations of the Glen Canyon and Flaming Gorge impoundment areas. Utah State Department of Fish and Game Informational Bulletin 60-3.
- McDonald, D.B. and P.A. Dotson. 1960. Federal aid in fish restoration investigations of specific problems in Utah's fishery. Utah State Department of Fish and Game Informational Bulletin 60-3.
- McKinney, T., W.R. Persons, and R.S. Rogers. 1999. Ecology of flannelmouth sucker in the Lee's Ferry tailwater, Colorado River, Arizona. *Great Basin Naturalist* 59(3):259-265.
- McLay, C. 1970. A theory concerning the distance traveled by animals entering the drift of a stream. *J. Fish. Res. Bd. Canada* 27:359-370.
- Miller, W.J., and J.A. Ptacek. 2000. Colorado pikeminnow habitat use in the San Juan River, New Mexico and Utah. Final Report. Miller Ecological Consultants, Inc. Fort Collins, CO.

- Minckley, W.L. 1991. Native fishes of arid lands: a dwindling resource of the desert southwest. USDA Forest Service, General Technical Report RM-206.
- Minckley, W.L. 1991. Native fishes of the Grand Canyon region: An obituary? Pages 124-177 in Colorado River ecology and dam management. Washington, DC: National Academy Press.
- Minckley, W.L., P.C. Marsh, J.E. Brooks, J.E. Johnson, and B L. Jensen. 1991. Management toward recovery of the razorback sucker. Chapter 17 of Battle Against Extinction. University of Arizona Press.
- Minckley, W.L. 1983. Status of the razorback sucker, *Xyrauchen texanus* (Abbott), in the lower Colorado River basin. The Southwestern Naturalist 28(2):165-187.
- Minckley, W.L., and P.B. Holden. 1980. *Catostomus latipinnis* Baird and Girard, flannelmouth sucker, page 381 in Atlas of North American freshwater fishes. D.S. Lee, C.R. Gilbert, C.H. Hocutt, R.E. Jenkins, D.E. McAllister, and J.R. Stauffer Jr. (eds). North Carolina State Museum of Natural History. Raleigh, NC.
- Modde, T., and E.J. Wick. 1996. Spring movement of razorback sucker in the middle Green River and comparison of juvenile growth and survival in wetlands. Final Report. U.S. Fish and Wildlife Service, Vernal, UT.
- Modde, T., K.P. Burnham, and E.J. Wick. 1996. Population status of the razorback sucker in the middle Green River (U.S.A.). Conservation Biology 10(1):110-119.
- Modde, T., Z.H. Bowen, and D.C. Kitcheyan. 2005. Spatial and temporal use of a spawning site in the middle Green River by wild and hatchery-reared razorback suckers. Transactions of the American Fisheries Society 134:937-944.
- Morris, J.E. 1993. Pond culture of channel catfish in the North Central Region. North Central Regional Aquaculture Center Extension Publication No. 444.
- Mueller, G.A. and R. Wydoski. 2004. Reintroduction of the flannelmouth sucker in the Lower Colorado River. North American Journal of Fisheries Management 24:41-46.
- Muth, R.T. and J.C. Schmulbach. 1984. Downstream transport of fish larvae in a shallow prairie river. Transactions of the American Fisheries Society 113:224-230.
- Nebeker, A.V., A.K. Hauck, F.D. Baker, and S.L. Weitz. 1980. Comparative responses of speckled dace and cutthroat trout to air-supersaturated water. Transactions of the American Fisheries Society 109:760-764.

- Nesler, T.P. 2001. Stocking plan for endangered Colorado River fish species in Colorado. Colorado Division of Wildlife, Denver, CO. 24 pp.
- Ohta, M. and T. Watanabe. 1996. Dietary energy budgets in carp. *Fisheries Science* 62(5):745-753.
- Osmundson, D.B. 1998. Longitudinal variation in temperature and fish community structure in the Upper Colorado River: implications for Colorado Pikeminnow food availability and range extension. U.S. Fish and Wildlife Service, Grand Junction, Colorado.
- Osmundson, D.B. 1999. Longitudinal variation in fish community structure and water temperature in the upper Colorado River: implications for Colorado pikeminnow habitat suitability. U.S. Fish and Wildlife Service, Grand Junction, CO.
- Osmundson, D.B., and L.R. Kaeding. 1990. Recommendations for flows in the 15 mile reach during October-June for maintenance and enhancement of endangered fish populations in the upper Colorado River. Final Report, U.S. Fish and Wildlife Service, Grand Junction, CO.
- Osmundson, D.B., and K.P. Burnham. 1996. Status of the Colorado squawfish in the upper Colorado River. Final Draft Report. U.S. Fish and Wildlife Service, Grand Junction, CO.
- Osmundson, D.B., R.J. Ryel, and T.E. Mourning. 1997. Growth and survival of Colorado squawfish in the upper Colorado River. *Transactions of the American Fisheries Society* 126:687-698.
- Osmundson, D.B., and K.P. Burnham. 1998. Status and trends of the endangered Colorado squawfish in the upper Colorado River. *Transactions of the American Fisheries Society* 127:957-970.
- Otis, E.O. 1994. Distribution, abundance, and composition of fishes in Bright Angel and Kanab Creeks, Grand Canyon National Park, Arizona. MS thesis, University of Arizona.
- Paukert, C. and R.S. Rogers. 2004. Factors affecting condition of flannelmouth suckers in the Colorado River, Grand Canyon, Arizona. *North American Journal of Fisheries Management* 24:648-653.
- Payer, R.D., and Scalet, C.G. 1978. Population and production estimates of fathead minnows in a South Dakota prairie wetland. *Progressive Fish-Culturist* 40:63-66.

- Pearsons, T.N., H.W. Li and G.A. Lamberti. 1992. Influence of habitat complexity on resistance to flooding and resilience of stream fish assemblages. *Transactions of the American Fisheries Society* 121:427-436.
- Péry, A.R., R. Mons, P. Flammarion, L. Lagadic, and J. Garric. 2002. A modeling approach to link food availability, growth, emergence, and reproduction for the midge *Chironomus riparius*. *Environmental Toxicology and Chemistry* 21(11):2507-2513.
- Pery, A.R.R. and J.G. Raphael Mons. 2005. Modelling of the life cycle of *Chironomus* species using an energy-based model. *Chemosphere* 59 (2005) 247-253.
- Petersen, J.H. and D.L. Ward. 1999. Development and corroboration of a bioenergetics model for northern pikeminnow feeding on juvenile salmonids in the Columbia River. *Transactions of the American Fisheries Society* 128:784-801.
- Petersen, J.H. and C.P. Paukert. 2005. Development of a bioenergetics model for humpback chub and evaluation of water temperature changes in the Grand Canyon, Colorado River. *Transactions of the American Fisheries Society* 134:960-974.
- Pitlo, J. Jr. 1997. Response of upper Mississippi River channel catfish populations to changes in commercial harvest regulations. *North American Journal of Fisheries Management* 17:848-859.
- Platania, S.P. 1995. Reproductive biology and early life-history of Rio Grande silvery minnow, *Hybognathus amarus*. U.S. Army Corps of Engineers, Albuquerque District, Albuquerque, NM.
- Platania, S.P, R.K. Dudley, and S.L. Maruca. 2000. Drift of fishes in the San Juan River 1991-1997. Final Report. Division of Fishes, Museum of Southwestern Biology, University of New Mexico, Albuquerque, NM.
- Postma, J.F, M.C. Buvckert-de Jong, N. Staats, C. Davids. 1994. Chronic toxicity of cadmium to *Chironomus riparius* (Diptera: Chironomidae) at different food levels. *Archives of Environmental Contamination and Toxicology*.
- Propst, D.L., A.L. Hobbes, and R.D. Larson. 2003. Small-bodied fish monitoring San Juan River 1998-2001. San Juan River Basin Recovery Implementation Program, U.S. Fish and Wildlife Service, Region 2, Albuquerque, New Mexico.
- Propst, D.L. and K.B. Gido. 2004. Responses of native and nonnative fishes to natural flow regime mimicry in the San Juan River. *Transactions of the American Fisheries Society* 133:922-931.

- Quinn, S.P. and M.R. Ross. 1982. Annulus formation by white suckers and the reliability of pectoral fin rays for ageing them. *North American Journal of Fisheries Management* 2:204-208.
- Quist, M.C., and C.S. Guy. 1998. Population characteristics of channel catfish from the Kansas River, Kansas. *Journal of Freshwater Ecology* 13(3):351-359
- Quist, M.C., and C.S. Guy. 2001. Growth and mortality of prairie stream fishes: relations with fish community and instream habitat characteristics. *Ecology of Freshwater Fish* 10:88-96.
- Raibley, P.T., and L.A. Jahn. 1991. Characteristics of commercially harvested channel catfish from areas of the Mississippi River along Illinois: Commercial harvest and the 15.0 in. minimum length limit. *Journal of Freshwater Ecology* 6(4):363-376.
- Rajagopal, P.K. and R.H. Kramer. 1974. Respiratory metabolism of Utah chub, *Gila atraria* (Girard) and speckled dace, *Rhinichthys osculus* (Girard). *J. Fish Biol* (1974) 6, 215-222.
- Rieman, B.E. and R.C. Beamesderfer. 1990. Dynamics of a northern squawfish population and the potential to reduce predation on juvenile salmonids in a Columbia River reservoir. *North American Journal of Fisheries Management* 10:228-241.
- Robinson, C.T., and G.W. Minshall. 1998. Macroinvertebrate communities, secondary production, and life history patterns in two adjacent streams in Idaho, USA. *Arch. Hydrobiol.* 142(3)257-281.
- Robinson, E.H. and M.H. Li. Catfish Protein Nutrition. Mississippi Agricultural and Forestry Experiment Station.
- Robinson, E.H. and M.H. Li. A practical guide to nutrition, feeds, and feeding of catfish. Delta Branch Experiment Station, Mississippi State University, Stoneville, Mississippi.
- Runde, J.M. and R.A. Hellenthal. 2000. Behavioral responses of *Hydropsyche sparna* (Trichoptera: Hydropsychidae) and related species to deposited bedload sediment. *Environmental Entomology* 29(4)704-709.
- Ruppert, J.B., R.T. Muth, and T.P. Nesler. 1993. Predation on fish larvae by adult red shiner, Yampa and Green Rivers, Colorado. *The Southwestern Naturalist* 38(4)397-399.

- Ryden, D.W. 2000. Monitoring of experimentally stocked razorback sucker in the San Juan River: March 1994 through October 1997. U.S. Fish and Wildlife Service, Grand Junction, Colorado.
- Ryden, D.W. 2000. Adult Fish Community Monitoring on the San Juan River, 1991-1997. San Juan River Basin Recovery Implementation Program.
- Ryden, D.W. 2003. An augmentation plan for Colorado pikeminnow in the San Juan River, final report. U.S. Fish and Wildlife Service, Grand Junction, Colorado.
- Ryden, D.W. 2003. An augmentation plan for razorback sucker in the San Juan River. Final Report. An addendum to the *Five Year Augmentation Plan for Razorback Sucker in the San Juan River* (Ryden 1997). U.S. Fish and Wildlife Service, Grand Junction, Colorado.
- Ryden, D.W. 2001. Addendum to the "Five-year augmentation plan for razorback sucker in the San Juan River". U.S. Fish and Wildlife Service, Grand Junction, Colorado.
- Sanchez R, M. and A.C. Hendricks. 1997. Life history and secondary production of *Cheumatopsyche* spp. in a small Appalachian stream with two different land uses on its watershed. *Hydrobiologia* 354:127-139.
- Schwedler, T.E., M.L. Berry and D.R. King. 1989. Guide to raising catfish in a cage. 4-H Aquatic Science Project. Southern Regional Aquaculture Center, SRAC Publication No. 340.
- Scidmore, W.J. and A.W. Glass. 1953. Use of pectoral fin rays to determine age of the white sucker. *The Progressive Fish-Culturist* pages 114-115.
- Scoppettone, G.G. 1988. Growth and longevity of the Cui-ui and longevity of other catostomids and cyprinids in western North America. *Transactions of the American Fisheries Society* 117:301-307.
- Seethaler, K. 1978. Life history and ecology of the Colorado squawfish (*Ptychocheilus lucius*) in the upper Colorado River basin. M.S. Thesis, Utah State University.
- Scott, W.B., and E.S. Crossman. 1998. *Freshwater fishes of Canada*. Galt House Publications, Ltd., Oakville, Ontario.
- Shrable, J.B., O.W. Tiemeier, and C.W. Deyoe. 1969. Effects of temperature on rate of digestion by channel catfish. *Progressive Fish-Culturist* 31:131-138.

- Sibley, P.K., D.A. Benoit, G.T. Ankley. 1997. The significance of growth in *Chironomus tentans* sediment toxicity tests: relationships to reproduction and demographic endpoints. *Environmental Toxicology and Chemistry* 16:336-345.
- Sigler, W.F., and J.W. Sigler. 1987. *Fishes of the Great Basin: A natural history*. University of Nevada Press, Reno, NV.
- Silverstein, J.T., W.R. Wolters, and M. Holland. 1999. Evidence of differences in growth and food intake regulation in different genetic strains of channel catfish. *Journal of Fish Biology* 54, 607-615.
- Simco, B.A. and F.B. Cross. 1966. Factors affecting growth and production of channel catfish, *Ictalurus punctatus*. University of Kansas Publications, Museum of Natural History. Volume 17, No. 4, pp. 191-256.
- Slipke, J.W., A.D. Martin, J. Pitlo Jr., and M.J. Maceina. 2002. Use of the spawning potential ratio for the Upper Mississippi River channel catfish fishery. *North American Journal of Fisheries Management* 22:1295-1300.
- Smith, G.R. 1966. Distribution and evolution of the North American catostomid fishes of the subgenus *Pantosteus*, genus *Catostomus*. Univ. Mich., Mus. Zool. Misc. Pub. No 129.
- Sneed, K.E. A method for calculating the growth of channel catfish, *Ictalurus lacustris punctatus*.
- Snyder, D.E., and R.T. Muth. 1990. Descriptions and identification of razorback, flannelmouth, white, Utah, bluehead, and mountain sucker larvae and early juveniles. Contribution 38 of the Larval Fish Laboratory, Colorado State University, Fort Collins. Colorado. Technical Publication No. 38, Colorado Division of Wildlife.
- Southern Regional Aquaculture Center. 1998. Restricted feeding regimes increase production efficiency in channel catfish. SRAC Publication No. 189.
- Stecyk, J.A.W. and A.P. Farrell. 2002. Cardiorespiratory responses of the common carp (*Cyprinus carpio*) to severe hypoxia at three acclimation temperatures. *The Journal of Experimental Biology* 205, 759-768.
- Sublette, J.E., M.D. Hatch, and M.S. Sublette. 1990. *The fishes of New Mexico*. Albuquerque, NM: University of New Mexico Press.
- Swee U.B., and H.R. McCrimmon. 1966. Reproductive biology of the carp, *Cyprinus carpio* L., in Lake St. Lawrence, Ontario. *Transactions of the American Fisheries Society* 95(4):372-380.

- Toney, D.P. 1974. Observations on the propagation and rearing of two endangered species in a hatchery environment. Proceedings of the Annual Conference of the Western Association of State Game and Fish Commissions 54:252-259.
- Trudel, M. and D. Boisclair. 1994. Seasonal consumption by dace (*Phoxinus eox* x *P. neogaeus*): a comparison between field and bioenergetic model estimates. Can. J. Fish. Aquat. Sci. 51:2558-2567.
- Tyus, H.M. 1987. Distribution, reproduction, and habitat use of the razorback sucker in the Green River, Utah, 1979-1986. Transactions of the American Fisheries Society 116:111-116.
- Tyus, H.M. 1997. Razorback sucker draft recovery plan. U.S. Fish and Wildlife Service.
- Tyus, H.M. and C.A. Karp. 1990. Spawning and movements of razorback sucker, *Xyrauchen texanus*, in the Green River basin of Colorado and Utah. The Southwestern Naturalist 35(4):427-433.
- Tyus, H.M. and N.J. Nikirk. 1990. Abundance, growth, and diet of channel catfish, *Ictalurus punctatus*, in the Green and Yampa rivers, Colorado and Utah. Southwestern Naturalist 35:188-198.
- U.S. Geological Survey, Northern Prairie Wildlife Research Center. Influences of fathead minnows on phosphorus and nitrogen cycling in a prairie wetland.
- U.S. Fish and Wildlife Service. 1997. Razorback sucker (*Xyrauchen texanus*), draft recovery plan. U.S. Fish and Wildlife Service, Denver, CO.
- U.S. Fish and Wildlife Service. 2001. Draft final: Recovery goals for razorback sucker (*Xyrauchen texanus*) of the Colorado River Basin. A supplement and amendment to the razorback sucker recovery plan.
- Valdez, R.A. and S.W. Carothers. 1998. The aquatic ecosystem of the Colorado River in Grand Canyon. Grand Canyon data integration project synthesis report. Final report prepared for U.S. Bureau of Reclamation, Upper Colorado Region, Salt Lake City, Utah. 250 pp.
- Vanicek, C.D. 1967. Ecological studies of native Green River fishes below Flaming Gorge Dam, 1964-1966. Ph.D. thesis, Utah State University, Logan, UT.
- Vanicek, C.D. and R.H. Kramer. 1969. Life history of the Colorado squawfish, *Ptychocheilus lucius*, and the Colorado chub, *Gila robusta*, in the Green River in Dinosaur National Monument, 1964-1966. Transactions of the American Fisheries Society 98(2):193-208.

- Vigg, S. and C.C. Burley. 1991. Temperature-dependent maximum daily consumption of juvenile salmonids by northern squawfish (*Ptychocheilus oregonensis*) from the Columbia River. *Can. J. Fish. Aquat. Sci.* 48: 2491-2498.
- Vigg, S.T.P. Poe, L.A. Prendergast, and H.C. Hansel. 1991. Rates of consumption of juvenile salmonids and alternative prey fish by northern squawfish, walleyes, smallmouth bass, and channel catfish in John Day Reservoir, Columbia River. *Transactions of the American Fisheries Society* 120:421-438.
- Vives, S.P. 1993. Choice of spawning substrate in red shiner with comments on crevice spawning in *Cyprinella*. *Copeia* (1)229-232.
- Walser, C.A., and R.P. Phelps. 1993. Factors influencing the enumeration of channel catfish eggs. *Progressive Fish-Culturist* 55:195-198.
- Wang, Ji-Qiao, Huanliang Lui, Hongyu Po, and Lina Fan. 1997. Influence of salinity on food consumption, growth and energy conversion efficiency of common carp (*Cyprinus carpio*) fingerlings. *Aquaculture* 148 (1997) 115-124.
- Ward, D.L. and K.D. Hilwig. 2004. Effects of holding environment and exercise conditioning on swimming performance of southwestern native fishes. *North American Journal of Fisheries Management* 24:1083-1087.
- Weiss, S.J. 1993. Spawning, movement, and population structure of flannelmouth sucker in the Paria River. MS thesis, University of Arizona.
- Wesp, H.M. and A.C. Gibb. 2003. Do endangered razorback suckers have poor larval escape performance relative to introduced rainbow trout? *Transactions of the American Fisheries Society* 132:1166-1178.
- Willis, L.D., and A.C. Hendricks. 1992. Life history, growth, survivorship, and production of *Hydropsyche slossanae* in Mill Creek, Virginia. *Journal of the North American Benthological Society* 11:290-303.
- Witt, A. Jr. An improved instrument to section bones for age and growth determinations of fish. *The Progressive Fish-Culturist*.
- Wurts, W.A. Review of feeding practices for channel catfish production. Kentucky State University CEP at UK Research and Education Center, Princeton, Kentucky.
- Xie Xiao-Jun and Sun Ruyung. 1992. The bioenergetics of southern catfish (*Silurus meridionalis* Chen): growth rate as a function of ration level, body weight, and temperature. *Journal of Fish Biology* 40, 719-730.

Zhou, B.S., R.S.S. Wu, D.J. Randall, and P.K.S. Lam. 2001. Bioenergetics and RNA/DNA ratios in the common carp (*Cyprinus carpio*) under hypoxia. *J. Comp Physiol B* (2001) 171:49-57.

Zuellig, R.E., B.C. Kondratieff, and R.A. Thorp. 2004. Life cycle of the net-spinning caddisfly, *Cheumatopsyche analis* (Banks) (Trichoptera: Hydropsychidae), in two small front range urban streams, Fort Collins, Colorado. *Western North American Naturalist* 64(4)497-502.

APPENDIX D – Fish Population Estimates 1998-2001

Population estimate results- 1998
Reach 6 –

1998 Hatch Trading Post	Riffle				Run #1				Boat	
	Pop.Est	95% CI			Pop.Est	95% CI			Pop.Est	95% CI
Catdis (all)				Catdis YOY				Catcom ADT		
Pass 1	92			Pass 1	9			Pass 1		
Pass 2	133	(121, 147)		Pass 2	10	(10, 11)		Pass 2	1	(1, 1)
Pass 3	133	(130, 138)		Pass 3	10	(10, 10)		Pass 3	1	(1, 1)
Catdis YOY				Catlat (all)				Pass 4	1	(1, 1)
Pass 1	26			Pass 1	53			Pass 5	1	(1, 1)
Pass 2	48	(39, 66)		Pass 2	58	(58, 59)		Catdis (all)		
Pass 3	47	(44, 53)		Pass 3	60	(60, 61)		Pass 1	55	
Catdis JUV				Catlat YOY				Pass 2	209	(97, 408)
Pass 1	66			Pass 1	49			Pass 3	186	(124, 252)
Pass 2	86	(82, 93)		Pass 2	53	(53, 54)		Pass 4	268	(157, 381)
Pass 3	87	(86, 90)		Pass 3	55	(55, 56)		Pass 5	234	(184, 284)
Catlat (all)				Catlat JUV				Catdis JUV		
Pass 1	40			Pass 1	4			Pass 1	38	
Pass 2	45	(45, 47)		Pass 2	5	(5, 6)		Pass 2	95	(62, 151)
Pass 3	47	(47, 48)		Pass 3	5	(5, 5)		Pass 3	92	(75, 114)
Catlat YOY				Cyplut (all)				Pass 4	148	(97, 209)
Pass 1	11			Pass 1	3			Pass 5	145	(109, 182)
Pass 2	12	(12, 13)		Pass 2	5	(5, 8)		Catdis Adlt		
Pass 3	12	(12, 12)		Pass 3	8	(7, 15)		Pass 1	17	
Catlat JUV				Cyplut JUV				Pass 2	53	*
Pass 1	29			Pass 1	1	(1, 1)		Pass 3	144	(49, 439)
Pass 2	33	(33, 35)		Pass 2	2	(2, 26)		Pass 4	119	(60, 231)
Pass 3	35	(35, 36)		Pass 3	2	(2, 26)		Pass 5	86	(64, 116)
Cotbai JUV				Cyplut ADT				Catlat (all)		
Pass 1	23			Pass 1	3			Pass 1	107	
Pass 2	28	(28, 30)		Pass 2	4	(4, 6)		Pass 2	306	(178, 443)
Pass 3	29	(29, 30)		Pass 3	5	(5, 7)		Pass 3	308	(245, 371)
Cyplut ADT				Pimpro (all)				Pass 4	382	(309, 455)
Pass 1	1	(1, 1)		Pass 1	12			Pass 5	376	(331, 421)
Pass 2	1	(1, 1)		Pass 2	13	(13, 14)		Catlat JUV		
Pass 3	1	(1, 1)		Pass 3	13	(13, 13)		Pass 1	43	
Rhiosc (all)				Pimpro JUV				Pass 2	107	(70, 165)
Pass 1	2310			Pass 1	3			Pass 3	80	(75, 88)
Pass 2	2649	(2632, 2666)		Pass 2	3	(3, 3)		Pass 4	127	(98, 158)
Pass 3	2745	(2736, 2754)		Pass 3	3	(3, 3)		Pass 5	140	(111, 169)
Rhiosc JUV				Pimpro ADT				Catlat ADT		
Pass 1	1964			Pass 1	9			Pass 1	64	
Pass 2	2291	(2273, 2309)		Pass 2	10	(10, 11)		Pass 2	192	(108, 311)
Pass 3	2383	(2374, 2392)		Pass 3	10	(10, 10)		Pass 3	283	(149, 440)
Rhiosc ADT				Rhiosc (all)				Pass 4	252	(186, 318)
Pass 1	346			Pass 1	118			Pass 5	233	(200, 266)
Pass 2	361	(361, 363)		Pass 2	179	(160, 198)		Cypcar (all)		
Pass 3	364	(364, 364)		Pass 3	191	(180, 202)		Pass 1	12	
Cray (all)				Rhiosc JUV				Pass 2	18	(17, 23)
Pass 1	34			Pass 1	26			Pass 3	29	(23, 44)
Pass 2	68	(52, 95)		Pass 2	33	(32, 37)		Pass 4	41	(29, 67)
Pass 3	64	(59, 72)		Pass 3	34	(34, 36)		Pass 5	36	(31, 47)
				Rhiosc ADT				Cypcar JUV		
				Pass 1	92			Pass 1	4	
				Pass 2	146	(127, 166)		Pass 2	4	(4, 4)
				Pass 3	158	(146, 170)		Pass 3	4	(4, 4)
				Cray (all)				Pass 4	4	(4, 4)
				Pass 1	4			Pass 5	4	(4, 4)
				Pass 2	4	(4, 4)		Cypcar ADT		
				Pass 3	5	(5, 6)		Pass 1	8	
								Pass 2	16	(13, 28)
								Pass 3	33	(19, 79)
								Pass 4	56	(25, 160)
								Pass 5	37	(27, 59)
								Micsal (all)		
								Pass 1		
								Pass 2		
								Pass 3	1	(1, 1)
								Pass 4	1	(1, 1)
								Pass 5	1	(1, 1)
								Pimpro (all)		
								Pass 1		
								Pass 2	5	*
								Pass 3	8	(4, 50)
								Pass 4	4	(4, 8)
								Pass 5	4	(4, 6)
								Saltru (all)		
								Pass 1		
								Pass 2	1	(1, 1)
								Pass 3	1	(1, 1)
								Pass 4	1	(1, 1)
								Pass 5	1	(1, 1)

1998 Reach 6 Boat and Habitat original breakdowns
Habitat ≤ 150 mm, Boat > 150 mm

Riffle			Run #1			Boat		
	Pop.Est	95% CI		Pop.Est	95% CI		Pop.Est	95% CI
Catdis (all)			Catdis YOY	10	(10, 10)	Catcom ADT	1	(1,1)
Catdis JUV	86	(85,88)	Catlat (all)			Catdis (all)	215	(150, 280)
Catdis YOY	47	(44, 53)	Catlat JUV	4	(4,4)	Catdis Adlt	86	(64, 115)
Catlat (all)			Catlat YOY	55	(55, 56)	Catdis JUV	126	(81, 185)
Catlat JUV	34	(34,35)	Cray (all)	5	(5, 6)	Catlat (all)	345	(305, 385)
Catlat YOY	12	(12, 12)	Cyplut (all)	8	(7, 15)	Catlat ADT	233	(200, 266)
Cotbai ADT	29	(29, 30)	Cyplut ADT	5	(5, 7)	Catlat JUV	110	(91, 131)
Cray (all)	64	(59, 72)	Cyplut JUV	2	(2, 26)	Cypcar (all)	27	(27, 59)
Cyplut ADT	1	(1, 1)	Pimpro (all)	13	(13, 13)	Cypcar ADT	27	(27, 59)
Rhiosc (all)			Pimpro ADT	10	(10, 10)	Saltru (all)	1	(1, 1)
Rhiosc ADT	2743	(2734, 2752)	Pimpro JUV	3	(3, 3)			
Rhiosc JUV	2	(2, 2)	Rhiosc (all)	191	(180, 202)			
			Rhiosc ADT	158	(146, 170)			
			Rhiosc JUV	34	(34, 36)			

1998 Reach 6 Boat and Habitat with additional Catlat and Catdis breakdowns

Note: a * in the LCI or UCI indicates a non-descending removal pattern error

1998 Hatch Trading Post			Riffle		Run #1		Boat		
	Pop.Est	95% CI			Pop.Est	95% CI	Pop.Est	95% CI	
Catdis (all)	Pass 1 92		Catlat YOY	Pass 1 9			Catcom ADT	Pass 1 1	(1, 1)
	Pass 2 133	(121, 147)		Pass 2 10	(10, 11)			Pass 2 1	(1, 1)
	Pass 3 133	(130, 138)		Pass 3 10	(10, 10)			Pass 3 1	(1, 1)
Catdis YOY	Pass 1 26		Catlat (all)	Pass 1 53			Catdis (all)	Pass 4 1	(1, 1)
	Pass 2 48	(39, 66)		Pass 2 58	(58, 59)			Pass 5 1	(1, 1)
	Pass 3 47	(44, 53)		Pass 3 60	(60, 61)				
Catdis JUV	Pass 1 66		Catlat YOY	Pass 1 49				Pass 1 55	
	Pass 2 86	(82, 93)		Pass 2 53	(53, 54)			Pass 2 209	(97, 408)
	Pass 3 87	(86, 90)		Pass 3 55	(55, 56)			Pass 3 186	(124, 252)
Catlat (all)	Pass 1 40		Catlat JUV	Pass 1 4				Pass 4 268	(157, 381)
	Pass 2 45	(45, 47)		Pass 2 5	(5, 6)			Pass 5 234	(184, 284)
	Pass 3 47	(47, 48)		Pass 3 5	(5, 5)				
Catlat YOY	Pass 1 11		Cyplut (all)	Pass 1 3			Catdis JUV	Pass 1 38	
	Pass 2 12	(12, 13)		Pass 2 5	(5, 8)			Pass 2 95	(62, 151)
	Pass 3 12	(12, 12)		Pass 3 8	(7, 15)			Pass 3 92	(75, 114)
Catlat JUV	Pass 1 29		Cyplut JUV	Pass 1 1	(1, 1)			Pass 4 148	(97, 209)
	Pass 2 33	(33, 35)		Pass 2 2	(2, 26)			Pass 5 145	(109, 182)
	Pass 3 35	(35, 36)		Pass 3 3					
Cotbai JUV	Pass 1 23		Cyplut ADT	Pass 1 3			Catdis 301-410	Pass 1 14	
	Pass 2 28	(28, 30)		Pass 2 4	(4, 6)			Pass 2 112	(28, 622)
	Pass 3 29	(29, 30)		Pass 3 5	(5, 7)			Pass 3 96	(39, 265)
Cyplut ADT	Pass 1 1	(1, 1)	Pimpro (all)	Pass 1 12				Pass 4 105	(49, 231)
	Pass 2 1	(1, 1)		Pass 2 13	(13, 14)			Pass 5 78	(54, 115)
	Pass 3 1	(1, 1)		Pass 3 13	(13, 13)				
Rhiosc (all)	Pass 1 2310		Pimpro JUV	Pass 1 3			Catdis 411-500	Pass 1 3	
	Pass 2 2649	(2632, 2666)		Pass 2 3	(3, 3)			Pass 2 7	(6, 16)
	Pass 3 2745	(2736, 2754)		Pass 3 3	(3, 3)			Pass 3 10	(8, 21)
Rhiosc JUV	Pass 1 1964		Pimpro ADT	Pass 1 9				Pass 4 10	(9, 16)
	Pass 2 2291	(2273, 2309)		Pass 2 10	(10, 11)			Pass 5 9	(9, 11)
	Pass 3 2383	(2374, 2392)		Pass 3 10	(10, 10)				
Rhiosc ADT	Pass 1 346		Rhiosc (all)	Pass 1 118			Catdis 500+	Pass 1 0	
	Pass 2 361	(361, 363)		Pass 2 179	(160, 198)			Pass 2 1	(1, 1)
	Pass 3 364	(364, 364)		Pass 3 191	(180, 202)			Pass 3 1	(1, 1)
Cray (all)	Pass 1 34		Rhiosc JUV	Pass 1 26				Pass 4 1	(1, 1)
	Pass 2 68	(52, 95)		Pass 2 33	(32, 37)			Pass 5 1	(1, 1)
	Pass 3 64	(59, 72)		Pass 3 34	(34, 36)				
			Rhiosc ADT	Pass 1 92			Catdis Adlt	Pass 1 17	
				Pass 2 146	(127, 166)			Pass 2 53	-
				Pass 3 158	(146, 170)			Pass 3 144	(49, 439)
			Cray (all)	Pass 1 4				Pass 4 119	(60, 231)
				Pass 2 4	(4, 4)			Pass 5 86	(64, 116)
				Pass 3 5	(5, 6)				
							Catlat (all)	Pass 1 107	
								Pass 2 306	(178, 443)
								Pass 3 308	(245, 371)
								Pass 4 382	(309, 455)
								Pass 5 376	(331, 421)
							Catlat 61-300	Pass 1 33	
								Pass 2 67	(51, 95)
								Pass 3 52	(51, 55)
								Pass 4 89	(70, 114)
								Pass 5 97	(79, 118)
							Catlat 301-410	Pass 1 10	
								Pass 2 40	(19, 127)
								Pass 3 33	(24, 55)
								Pass 4 32	(27, 43)
								Pass 5 41	(32, 59)
							Catlat JUV	Pass 1 43	
								Pass 2 107	(70, 165)
								Pass 3 80	(75, 88)
								Pass 4 127	(98, 158)
								Pass 5 140	(111, 169)
							Catlat 411-500	Pass 1 52	
								Pass 2 112	(81, 154)
								Pass 3 203	(114, 316)
								Pass 4 178	(133, 223)
								Pass 5 180	(150, 210)
							Catlat 500+	Pass 1 12	
								Pass 2 41	-
								Pass 3 68	(35, 152)
								Pass 4 74	(43, 136)
								Pass 5 51	(44, 63)
							Catlat ADT	Pass 1 64	
								Pass 2 192	(108, 311)
								Pass 3 283	(149, 440)
								Pass 4 252	(186, 318)
								Pass 5 233	(200, 266)
							Cypcar (all)	Pass 1 12	
								Pass 2 18	(17, 23)
								Pass 3 29	(23, 44)
								Pass 4 41	(29, 67)
								Pass 5 36	(31, 47)
							Cypcar JUV	Pass 1 4	
								Pass 2 4	(4, 4)
								Pass 3 4	(4, 4)
								Pass 4 4	(4, 4)
								Pass 5 4	(4, 4)
							Cypcar ADT	Pass 1 8	
								Pass 2 16	(13, 28)
								Pass 3 33	(19, 79)
								Pass 4 56	(25, 160)
								Pass 5 37	(27, 59)
							Micsal (all)	Pass 1 1	
								Pass 2 1	
								Pass 3 1	(1, 1)
								Pass 4 1	(1, 1)
								Pass 5 1	(1, 1)
							Pimpro (all)	Pass 1 5	
								Pass 2 8	(4, 50)
								Pass 3 4	(4, 8)
								Pass 4 4	(4, 6)
								Pass 5 4	(4, 6)
							Saltru (all)	Pass 1 1	
								Pass 2 1	(1, 1)
								Pass 3 1	(1, 1)
								Pass 4 1	(1, 1)
								Pass 5 1	(1, 1)

1998 Sand Island:

1998 Reach 3 Boat and Habitat original breakdowns
 Habitat ≤ 150 mm, Boat > 150 mm

Note: a * in the LCI or UCI indicates a non-descending removal pattern error

1998 Sand Island	Rifle		Run #2		Run #1		Boat				
	Pop.Est	95 % CI	Pop.Est	95 % CI	Pop.Est	95 % CI	Pop.Est	95 % CI			
Catlat (all)	25	(25, 26)	Ictpun (all)	60	(53, 71)	Catlat JUV	1	(1, 1)	Amemel (all)	1	(1, 1)
Catlat JUV	24	(24, 25)	Ictpun JUV	10	(9, 16)	Cyplut JUV	1	(1, 1)	Catdis (all)	6	(6, 8)
Catlat YOY	1	(1, 1)	Ictpun YOY	48	(44, 56)	Ictpun (all)	56	(51, 64)	Catdis Adlt	4	(4, 7)
Cyplut ADT	5	(5, 6)			Ictpun JUV	32	(31, 35)	Catdis JUV	2	(2, 9)	
Ictpun (all)	201	(197, 206)			Ictpun YOY	24	(20, 35)	Catlat (all)	229	(126, 352)	
Ictpun JUV	153	(149, 158)			Rhiosc ADT	1	(1, 1)	Catlat ADT	53	(39, 78)	
Ictpun YOY	48	(48, 50)						Catlat JUV	182	(87, 337)	
Pimpro ADT	1	(1, 1)						Cypcar (all)	35	(27, 52)	
Rhiosc ADT	133	(131, 137)						Cypcar ADT	33	(25, 52)	
								Cypcar JUV	2	(2, 9)	
								Ictpun (all)	473	(295, 650)	
								Ictpun ADT	75	(48, 122)	
								Ictpun JUV	391	(224, 558)	
								Ptyluc (all)	1	(1, 1)	
								Stivit (all)	1	(1, 1)	

1998 Sand Island	Riffle		Run #2		Run #1		Boat				
	Pop.Est	95 % CI	Pop.Est	95 % CI	Pop.Est	95 % CI	Pop.Est	95 % CI			
Catlat (all)	Pass 1	31	Cypcar ADT	Pass 1	3	Catlat (all)	Pass 1	1	Amemel (all)	Pass 1	1
	Pass 2	35 (35, 37)		Pass 2	3 (3, 3)		Pass 2	1 (1, 1)		Pass 2	1 (1, 1)
	Pass 3	36 (36, 37)		Pass 3	3 (3, 3)		Pass 3	1 (1, 1)		Pass 3	1 (1, 1)
	Pass 4	37 (37, 37)		Pass 4	3 (3, 3)		Pass 4	6 (3, 46)		Pass 4	1 (1, 1)
Catlat YOY	Pass 1	1	Ictpun (all)	Pass 1	40	Catlat JUV	Pass 1	1	Catdis (all)	Pass 1	9 *
	Pass 2	1 (1, 1)		Pass 2	57 (53, 65)		Pass 2	1 (1, 1)		Pass 2	8 (6, 22)
	Pass 3	1 (1, 1)		Pass 3	70 (64, 79)		Pass 3	1 (1, 1)		Pass 3	6 (6, 8)
	Pass 4	1 (1, 1)		Pass 4	72 (69, 78)		Pass 4	2 (2, 15)	Catdis 61-300	Pass 4	2 (2, 10)
Catlat 61-300	Pass 1	28	Ictpun YOY	Pass 1	4	Catlat ADLT	Pass 1	2 (2, 10)		Pass 1	3 *
	Pass 2	32 (32, 34)		Pass 2	5 (5, 6)		Pass 2	1 (1, 1)		Pass 2	2 (2, 15)
	Pass 3	33 (33, 34)		Pass 3	7 (7, 10)		Pass 3	1 (1, 1)		Pass 3	2 (2, 9)
	Pass 4	34 (34, 35)		Pass 4	10 (9, 16)		Pass 4	1 (1, 1)	Catdis 301-410	Pass 4	2 (2, 9)
Catlat 301-411	Pass 1	2	Ictpun JUV	Pass 1	33		Pass 5	1 (1, 1)		Pass 1	6 *
	Pass 2	2 (2, 2)		Pass 2	50 (45, 60)		Pass 5	1 (1, 1)		Pass 2	4 (4, 9)
	Pass 3	2 (2, 2)		Pass 3	59 (54, 68)					Pass 3	4 (4, 7)
	Pass 4	2 (2, 2)		Pass 4	59 (57, 63)					Pass 4	4 (4, 7)
Catlat JUV	Pass 1	30	Ictpun ADLT	Pass 1	3				Catlat (all)	Pass 1	45
	Pass 2	34 (34, 36)		Pass 2	3 (3, 3)					Pass 2	105 (72, 155)
	Pass 3	35 (35, 36)		Pass 3	3 (3, 3)					Pass 3	238 (105, 457)
	Pass 4	36 (36, 37)		Pass 4	3 (3, 3)					Pass 4	241 (129, 377)
Cyplut ADT	Pass 1	3				Ictpun (all)	Pass 1	28	Catlat 61-300	Pass 1	13
	Pass 2	5 (5, 8)					Pass 2	31 (31, 32)		Pass 2	32 (22, 61)
	Pass 3	5 (5, 8)					Pass 3	47 (42, 56)		Pass 3	47 (30, 87)
	Pass 4	5 (5, 6)					Pass 4	61 (51, 76)		Pass 4	51 (36, 80)
Ictpun (all)	Pass 1	135				Ictpun YOY	Pass 5	64 (56, 76)	Catlat 301-410	Pass 1	17
	Pass 2	171 (164, 179)					Pass 1	10		Pass 2	46 (29, 90)
	Pass 3	199 (190, 208)					Pass 2	10 (10, 10)		Pass 3	61 (39, 105)
	Pass 4	204 (200, 209)					Pass 3	13 (13, 15)		Pass 4	179 (54, 582)
Ictpun YOY	Pass 1	33					Pass 4	19 (17, 26)	Catlat JUV	Pass 1	30
	Pass 2	44 (42, 49)					Pass 5	24 (20, 35)		Pass 2	87 (51, 160)
	Pass 3	47 (46, 50)				Ictpun JUV	Pass 1	18		Pass 3	116 (69, 190)
	Pass 4	48 (48, 50)					Pass 2	21 (21, 23)		Pass 4	197 (90, 376)
Ictpun JUV	Pass 1	102					Pass 3	34 (29, 45)	Catlat 411-500	Pass 1	15
	Pass 2	126 (122, 132)					Pass 4	39 (34, 49)		Pass 2	23 (21, 30)
	Pass 3	152 (144, 161)					Pass 5	39 (36, 45)		Pass 3	54 *
	Pass 4	156 (152, 161)				Rhiose ADT	Pass 1	1		Pass 4	53 (39, 78)
Pimpro ADT	Pass 1	1					Pass 2	1 (1, 1)	Cypcar (all)	Pass 1	8
	Pass 2	1 (1, 1)					Pass 3	1 (1, 1)		Pass 2	29 *
	Pass 3	1 (1, 1)					Pass 4	1 (1, 1)		Pass 3	34 (23, 63)
	Pass 4	1 (1, 1)					Pass 5	1 (1, 1)		Pass 4	35 (27, 53)
Rhiose ADT	Pass 1	94							Cypcar JUV	Pass 1	3 *
	Pass 2	112 (110, 116)								Pass 2	2 (2, 15)
	Pass 3	125 (123, 129)								Pass 3	2 (2, 9)
	Pass 4	133 (131, 137)								Pass 4	2 (2, 9)
									Cypcar ADT	Pass 1	8
										Pass 2	80 (17, 661)
										Pass 3	29 (21, 51)
										Pass 4	33 (25, 52)
						Ictpun (all)	Pass 1	102	Ictpun (all)	Pass 1	102
							Pass 2	365 (177, 602)		Pass 2	365 (177, 602)
							Pass 3	392 (259, 525)		Pass 3	392 (259, 525)
							Pass 4	686 (336, 1036)		Pass 4	686 (336, 1036)
						Ictpun YOY	Pass 1	4	Ictpun YOY	Pass 1	4
							Pass 2	4 (4, 4)		Pass 2	4 (4, 4)
							Pass 3	6 (6, 9)		Pass 3	6 (6, 9)
							Pass 4	17 *		Pass 4	17 *
						Ictpun JUV	Pass 1	82	Ictpun JUV	Pass 1	82
							Pass 2	299 (143, 521)		Pass 2	299 (143, 521)
							Pass 3	317 (197, 437)		Pass 3	317 (197, 437)
							Pass 4	551 (247, 861)		Pass 4	551 (247, 861)
						Ictpun ADT	Pass 1	16	Ictpun ADT	Pass 1	16
							Pass 2	72 (30, 224)		Pass 2	72 (30, 224)
							Pass 3	61 (39, 105)		Pass 3	61 (39, 105)
							Pass 4	75 (48, 122)		Pass 4	75 (48, 122)
						Stivit (all)	Pass 1	1	Stivit (all)	Pass 1	1
							Pass 2	1 (1, 1)		Pass 2	1 (1, 1)
							Pass 3	1 (1, 1)		Pass 3	1 (1, 1)
							Pass 4	1 (1, 1)		Pass 4	1 (1, 1)
						Ptyluc (all)	Pass 1	1	Ptyluc (all)	Pass 1	1
							Pass 2	1 (1, 1)		Pass 2	1 (1, 1)
							Pass 3	1 (1, 1)		Pass 3	1 (1, 1)
							Pass 4	1 (1, 1)		Pass 4	1 (1, 1)

Population estimate results- 1999:

Reach 3 -

Habitat < 150 mm, Boat > 150 mm
 Note: an * in the 95% indicates a non-descending removal pattern error

Run, RM 95.6			Run, RM 95.7			Run, RM 97.9			Rifle, RM 95.7			Rifle, RM 97.9			Rifle, RM 100.6			Boat, RM 104.5-103.5		
Pop. Est.	95% CI		Pop. Est.	95% CI		Pop. Est.	95% CI		Pop. Est.	95% CI		Pop. Est.	95% CI		Pop. Est.	95% CI		Pop. Est.	95% CI	
Ictpun Juvenile	1	(1, 1)	Catlat Juvenile	1	(1, 1)	Rhiosc Adult	2	(2, 7)	Rhiosc Adult	6	(6, 6)	Rhiosc Adult	7	(7, 8)	Rhiosc Adult	12	(12, 13)	Catlat (all)	27	Total
Rhiosc Adult	2	(2, 7)	Cyphlat Adult	1	(1, 1)													Catlat Adult	15	Total
Cyphlat Adult	3	(3, 3)	Rhiosc Adult	2	(2, 2)													Catlat Juvenile	15	(12, 27)
																		Catlat (all)	582	(304, 860)
																		Catlat Adult	406	(147, 828)
																		Catlat Juvenile	215	(130, 308)
																		Cyphlat Adult	95	(68, 132)
																		Ictpun (all)	592	(440, 744)
																		Ictpun Adult	122	(73, 194)
																		Ictpun Juvenile	464	(335, 593)
																		Phyloc JUV	1	Total
																		Xyretes Adh	6	(4, 25)

Reach 4 -

1999 Reach 4 Original and New Catlat and Catlat Breakdowns combined
 Note: an * in the 95% indicates a non-descending removal pattern error

Run, RM 111.2			Run, RM 113.8			Run, RM 116.1			Rifle, RM 113.8			Rifle, RM 116.1			Rifle, RM 118.0			Rifle, RM 130.4		
Pop. Est.	95% CI		Pop. Est.	95% CI		Pop. Est.	95% CI		Pop. Est.	95% CI		Pop. Est.	95% CI		Pop. Est.	95% CI		Pop. Est.	95% CI	
Catlat (all)	Pass 1	1	Ictpun (all)	Pass 1	1	Catlat (all)	Pass 1	1	Rhiosc (all)	Pass 1	53	Rhiosc (all)	Pass 1	11	Rhiosc (all)	Pass 1	11	Rhiosc (all)	Pass 1	23
	Pass 2	2		Pass 2	2		Pass 2	2		Pass 2	67		Pass 2	13		Pass 2	13		Pass 2	35
	Pass 3	2		Pass 3	2		Pass 3	2		Pass 3	68		Pass 3	13		Pass 3	13		Pass 3	43
	Pass 4	2		Pass 4	2		Pass 4	2		Pass 4	68		Pass 4	13		Pass 4	13		Pass 4	43
Catlat Juvenile	Pass 1	1	Ictpun Adult	Pass 1	1	Catlat 411-501	Pass 1	1	Rhiosc Adult	Pass 1	53	Rhiosc Adult	Pass 1	11	Rhiosc Adult	Pass 1	11	Rhiosc Adult	Pass 1	23
	Pass 2	2		Pass 2	2		Pass 2	2		Pass 2	67		Pass 2	13		Pass 2	13		Pass 2	35
	Pass 3	2		Pass 3	2		Pass 3	2		Pass 3	68		Pass 3	13		Pass 3	13		Pass 3	43
	Pass 4	2		Pass 4	2		Pass 4	2		Pass 4	68		Pass 4	13		Pass 4	13		Pass 4	43
Catlat Juvenile	Pass 1	1	Rhiosc (all)	Pass 1	1	Catlat Adult	Pass 1	1												
	Pass 2	2		Pass 2	2		Pass 2	2												
	Pass 3	2		Pass 3	2		Pass 3	2												
	Pass 4	2		Pass 4	2		Pass 4	2												
Ictpun (all)	Pass 1	6	Rhiosc Adult	Pass 1	2		Pass 1	2												
	Pass 2	48		Pass 2	2		Pass 2	2												
	Pass 3	15		Pass 3	2		Pass 3	2												
	Pass 4	14		Pass 4	2		Pass 4	2												
Ictpun Juvenile	Pass 1	5		Pass 1	2		Pass 1	2												
	Pass 2	18		Pass 2	2		Pass 2	2												
	Pass 3	12		Pass 3	2		Pass 3	2												
	Pass 4	12		Pass 4	2		Pass 4	2												
Ictpun Adult	Pass 1	1		Pass 1	2		Pass 1	2												
	Pass 2	1		Pass 2	2		Pass 2	2												
	Pass 3	2		Pass 3	2		Pass 3	2												
	Pass 4	2		Pass 4	2		Pass 4	2												

1999 Reach 4 Rifle Data with Original Breakdowns

Note: an * in the 95% indicates a non-descending removal pattern error

Rifle, RM 113.8			Rifle, RM 116.1			Rifle, RM 118.0			Rifle, RM 130.4		
Pop. Est.	95% CI		Pop. Est.	95% CI		Pop. Est.	95% CI		Pop. Est.	95% CI	
Rhiosc (all)	Pass 1	53	Rhiosc (all)	Pass 1	16	Rhiosc (all)	Pass 1	11	Rhiosc (all)	Pass 1	23
	Pass 2	67		Pass 2	20		Pass 2	13		Pass 2	35
	Pass 3	68		Pass 3	20		Pass 3	13		Pass 3	43
Rhiosc Adult	Pass 1	53	Rhiosc Adult	Pass 1	16	Rhiosc Adult	Pass 1	11	Rhiosc Adult	Pass 1	23
	Pass 2	67		Pass 2	20		Pass 2	13		Pass 2	35
	Pass 3	68		Pass 3	20		Pass 3	13		Pass 3	43

1999 Reach 4 Run Data with Original Breakdowns

Note: an * in the 95% indicates a non-descending removal pattern error

Run, RM 111.2			Run, RM 113.8			Run, RM 116.1		
Pop. Est.	95% CI		Pop. Est.	95% CI		Pop. Est.	95% CI	
Catlat (all)	Pass 1	1	Ictpun (all)	Pass 1	1	Catlat (all)	Pass 1	3
	Pass 2	2		Pass 2	1		Pass 2	3
	Pass 3	2		Pass 3	1		Pass 3	3
	Pass 4	2		Pass 4	2		Pass 4	3
Catlat Juvenile	Pass 1	1	Ictpun Adult	Pass 1	1	Catlat Adult	Pass 1	3
	Pass 2	2		Pass 2	1		Pass 2	3
	Pass 3	2		Pass 3	1		Pass 3	3
	Pass 4	2		Pass 4	2		Pass 4	3
Ictpun (all)	Pass 1	6	Rhiosc (all)	Pass 1	2		Pass 1	2
	Pass 2	48		Pass 2	2		Pass 2	2
	Pass 3	15		Pass 3	2		Pass 3	2
	Pass 4	14		Pass 4	2		Pass 4	2
Ictpun Juvenile	Pass 1	5	Rhiosc Adult	Pass 1	2		Pass 1	2
	Pass 2	18		Pass 2	2		Pass 2	2
	Pass 3	12		Pass 3	2		Pass 3	2
	Pass 4	12		Pass 4	2		Pass 4	2
Ictpun Adult	Pass 1	1		Pass 1	1		Pass 1	1
	Pass 2	1		Pass 2	1		Pass 2	1
	Pass 3	2		Pass 3	2		Pass 3	2
	Pass 4	2		Pass 4	2		Pass 4	2

1999 Reach 4 Run Data with New Catlat and Catdis Breakdowns

Note: an * in the 95% indicates a non-descending removal pattern error

1999 Reach 4		Run, RM 111.2		Run, RM 113.8		Run, RM 116.1	
		Pop. Est.	95% CI	Pop. Est.	95% CI	Pop. Est.	95% CI
Catlat (all)	Pass 1	1		1		3	
	Pass 2	2	(2-15)	1	(1-1)	3	(3-3)
	Pass 3	2	(2-7)	1	(1-1)	3	(3-3)
	Pass 4	2	(2-4)				
Catlat 301-410	Pass 1	1		1		3	
	Pass 2	2	(2-15)	1	(1-1)	3	(3-3)
	Pass 3	2	(2-7)	1	(1-1)	3	(3-3)
	Pass 4	2	(2-4)				
Ictpun (all)	Pass 1	6		2			
	Pass 2	48	(13-344)	2	(2-2)		
	Pass 3	15	(14-20)	2	(2-2)		
	Pass 4	14	(14-16)	2	(2-2)		
Ictpun Juvenile	Pass 1	5		2			
	Pass 2	18	*				
	Pass 3	12	(12-15)				
	Pass 4	12	(12-13)				
Ictpun Adult	Pass 1	1					
	Pass 2	1	(1-1)				
	Pass 3	2	(2-15)				
	Pass 4	2	(2-9)				

Reach 5 –

1999 Reach 5 Original and New Catlat and Catdis Breakdowns combined

Note: an * in the 95% indicates a non-descending removal pattern error

1999 Reach 5		Run, RM 131.7		Rifle, RM 133.4		Rifle, RM 134.2		Rifle, RM 136.2		Boat, RM 149-148	
		Pop. Est.	95% CI	Pop. Est.	95% CI	Pop. Est.	95% CI	Pop. Est.	95% CI	Pop. Est.	95% CI
Catlat (all)	Pass 1	1		2		24		1		20	
	Pass 2	1	(1-1)	2	(2-2)	25	(25-25)	1	(1-1)	80	*
	Pass 3	1		2	(2-2)	25	(25-25)	1	(1-1)	117	*
	Pass 4	1								314	(95-844)
Catlat 411-500	Pass 1	1									
	Pass 2	1	(1-1)								
Catlat Adult	Pass 1	1		2		24		1		6	
	Pass 2	1	(1-1)	2	(2-2)	25	(25-25)	1	(1-1)	42	*
	Pass 3	1		2	(2-2)	25	(25-25)	1	(1-1)	63	*
	Pass 4	1								75	*
Ictpun (all)	Pass 1	7									
	Pass 2	7	(7-7)								
Ictpun Juvenile	Pass 1	2									
	Pass 2	2	(2-2)								
Ictpun Adult	Pass 1	5									
	Pass 2	5	(5-5)								

1999 Reach 5 Riffle Data with Original Breakdowns

Note: an * in the 95% indicates a non-descending removal pattern error
1999 Reach 5

Riffle, RM 133.4			Riffle, RM 134.2			Riffle, RM 136.2		
	Pop. Est.	95% CI		Pop. Est.	95% CI		Pop. Est.	95% CI
Rhiosc (all)			Rhiosc (all)			Catdis		
Pass 1	2		Pass 1	24		Pass 1	1	
Pass 2	2	(2-2)	Pass 2	25	(25-25)	Pass 2	1	(1-1)
Pass 3	2	(2-2)	Pass 3	25	(25-25)	Pass 3	1	(1-1)
Rhiosc Adult			Rhiosc Adult			Catdis Juvenile		
Pass 1	2		Pass 1	24		Pass 1	1	
Pass 2	2	(2-2)	Pass 2	25	(25-25)	Pass 2	1	(1-1)
Pass 3	2	(2-2)	Pass 3	25	(25-25)	Pass 3	1	(1-1)
						Cyplut		
						Pass 1	1	
						Pass 2	1	(1-1)
						Pass 3	1	(1-1)
						Cyplut Adult		
						Pass 1	1	
						Pass 2	1	(1-1)
						Pass 3	1	(1-1)
						Rhiosc (all)		
						Pass 1	17	
						Pass 2	21	(21-23)
						Pass 3	22	(22-23)
						Rhiosc Adult		
						Pass 1	17	
						Pass 2	21	(21-23)
						Pass 3	22	(22-23)

1999 Reach 5 Run Data with Original Breakdowns

Note: an * in the 95% indicates a non-descending removal pattern error

1999 Reach 5		Run, RM 131.7	
		Pop. Est.	95% CI
Catlat (all)			
	Pass 1	1	
	Pass 2	1	(1-1)
Catlat Adult			
	Pass 1	1	
	Pass 2	1	(1-1)
Ictpun (all)			
	Pass 1	7	
	Pass 2	7	(7-7)
Ictpun Juvenile			
	Pass 1	2	
	Pass 2	2	(2-2)
Ictpun Adult			
	Pass 1	5	
	Pass 2	5	(5-5)

1999 Reach 5 Run Data with New Catlat and Catdis Breakdowns

Note: an * in the 95% indicates a non-descending removal pattern error

1999 Reach 5		Run, RM 131.7	
		Pop. Est.	95% CI
Catlat (all)	Pass 1	1	
	Pass 2	1	(1-1)
Catlat 411-500	Pass 1	1	
	Pass 2	1	(1-1)
Ictpun (all)	Pass 1	7	
	Pass 2	7	(7-7)
Ictpun Juvenile	Pass 1	2	
	Pass 2	2	(2-2)
Ictpun Adult	Pass 1	5	
	Pass 2	5	(5-5)

1999 Reach 5 Boat Data with Original Breakdowns

Note: an * in the 95% indicates a non-descending removal pattern error
1999 Reach 5

		Boat, RM 149-148	
		Pop. Est.	95% CI
Catdis	Pass 1	20	
	Pass 2	80	*
	Pass 3	117	*
	Pass 4	314	(95-844)
Catdis Juvenile	Pass 1	6	
	Pass 2	42	*
	Pass 3	63	*
	Pass 4	75	*
Catdis Adult	Pass 1	14	
	Pass 2	44	(25-102)
	Pass 3	83	(36-220)
	Pass 4	91	(45-194)
Catlat (all)	Pass 1	84	
	Pass 2	294	*
	Pass 3	407	*
	Pass 4	450	(352-548)
Catlat Juvenile	Pass 1	39	
	Pass 2	168	*
	Pass 3	236	*
	Pass 4	282	(181-383)
Catlat Adult	Pass 1	45	
	Pass 2	262	(84-746)
	Pass 3	236	(114-413)
	Pass 4	171	(130-212)
Cypcar	Pass 1	23	
	Pass 2	71	(40-145)
	Pass 3	207	(60-687)
	Pass 4	180	(75-390)
Cypcar Adult	Pass 1	23	
	Pass 2	71	(40-145)
	Pass 3	207	(60-687)
	Pass 4	180	(75-390)
Ictpun (all)	Pass 1	195	
	Pass 2	474	(355-593)
	Pass 3	884	(569-1199)
	Pass 4	782	(649-915)
Ictpun Juvenile	Pass 1	128	
	Pass 2	405	(217-600)
	Pass 3	729	(314-1144)
	Pass 4	559	(437-681)
Ictpun Adult	Pass 1	67	
	Pass 2	110	(94-130)
	Pass 3	201	(132-273)
	Pass 4	220	(165-275)
Ptyluc	Pass 1	0	
	Pass 2	3	*
	Pass 3	2	(2-15)
	Pass 4	2	(2-9)
Ptyluc Juvenile	Pass 1	0	
	Pass 2	3	*
	Pass 3	2	(2-15)
	Pass 4	2	(2-9)

1999 Reach 5 Boat Data with New Catlat and Catdis Breakdowns

Note: an * in the 95% indicates a non-descending removal pattern error
1999 Reach 5

		Boat, RM 149-148	
		Pop. Est.	95% CI
Catdis	Pass 1	20	
	Pass 2	80	*
	Pass 3	117	*
	Pass 4	314	(95-844)
Catdis Juvenile	Pass 1	6	
	Pass 2	42	*
	Pass 3	63	*
	Pass 4	75	*
Catdis 301-410	Pass 1	12	
	Pass 2	56	(23-195)
	Pass 3	86	(33-266)
	Pass 4	101	(42-261)
Catdis Adult	Pass 1	14	
	Pass 2	44	(25-102)
	Pass 3	83	(36-220)
	Pass 4	91	(45-194)
Catlat (all)	Pass 1	84	
	Pass 2	294	*
	Pass 3	407	*
	Pass 4	450	(352-548)
Catlat Juvenile	Pass 1	39	
	Pass 2	168	*
	Pass 3	236	*
	Pass 4	282	(181-383)
Catlat 411-500	Pass 1	30	
	Pass 2	93	*
	Pass 3	223	(87-499)
	Pass 4	137	(98-181)
Catlat 501+	Pass 1	10	
	Pass 2	12	(12-13)
	Pass 3	36	(20-88)
	Pass 4	27	(22-39)
Catlat Adult	Pass 1	45	
	Pass 2	262	(84-746)
	Pass 3	236	(114-413)
	Pass 4	171	(130-212)
Cypcar	Pass 1	23	
	Pass 2	71	(40-145)
	Pass 3	207	(60-687)
	Pass 4	180	(75-390)
Cypcar Adult	Pass 1	23	
	Pass 2	71	(40-145)
	Pass 3	207	(60-687)
	Pass 4	180	(75-390)
Ictpun (all)	Pass 1	195	
	Pass 2	474	(355-593)
	Pass 3	884	(569-1199)
	Pass 4	782	(649-915)
Ictpun Juvenile	Pass 1	128	
	Pass 2	405	(217-600)
	Pass 3	729	(314-1144)
	Pass 4	559	(437-681)
Ictpun Adult	Pass 1	67	
	Pass 2	110	(94-130)
	Pass 3	201	(132-273)
	Pass 4	220	(165-275)
Ptyluc	Pass 1	0	
	Pass 2	3	*
	Pass 3	2	(2-15)
	Pass 4	2	(2-9)
Ptyluc Juvenile	Pass 1	0	
	Pass 2	3	*
	Pass 3	2	(2-15)
	Pass 4	2	(2-9)

Reach 6 –

1999 Reach 6 Original and New Catlat and Caddis Breakdowns combined

Note: an * in the 95% indicates a non-descending removal pattern error

1999 Reach 6			Run, RM 161.0			Run, RM 161.3			Run, RM 164.6			Run, RM 161.0			Run, RM 162.4			Run, RM 165.6		
	Pop. Est.	95% CI		Pop. Est.	95% CI		Pop. Est.	95% CI		Pop. Est.	95% CI		Pop. Est.	95% CI		Pop. Est.	95% CI		Pop. Est.	95% CI
Catlat (all)	3		Catlat (all)	5		Catlat (all)	1		Rhiosc (all)	8		Catlat (all)	1		Catlat (all)	1		Catlat (all)	1	
Pass 1	3		Pass 1	5		Pass 1	1		Pass 1	8		Pass 1	1		Pass 1	1		Pass 1	1	
Pass 2	5 (5-8)		Pass 2	5 (5-8)		Pass 2	1 (1-1)		Pass 2	8 (8-8)		Pass 2	1 (1-1)		Pass 2	1 (1-1)		Pass 2	1 (1-1)	
Pass 3	5 (5-6)		Pass 3	5 (5-6)		Pass 3	1 (1-1)		Rhiosc Adult	8		Pass 3	1 (1-1)		Pass 3	1 (1-1)		Pass 3	2 (2-15)	
Catlat 61-300	3		Catlat YOY	5		Catlat 411-500	1		Catlat Adult	8		Catlat 61-300	1		Catlat Juvenile	1		Catlat Juvenile	1	
Pass 1	3		Pass 1	5		Pass 1	1		Pass 1	8		Pass 1	1		Pass 1	1		Pass 1	1	
Pass 2	3 (3-3)		Pass 2	1 (1-1)		Pass 2	1 (1-1)		Pass 2	1 (1-1)		Pass 2	1 (1-1)		Pass 2	1 (1-1)		Pass 2	1 (1-1)	
Pass 3	3 (3-3)		Pass 3	1 (1-1)		Pass 3	1 (1-1)		Pass 3	1 (1-1)		Pass 3	1 (1-1)		Pass 3	1 (1-1)		Pass 3	2 (2-15)	
Catlat Juvenile	3		Catlat 61-300	1		Catlat Adult	1		Rhiosc (all)	1		Catlat Juvenile	1		Cypcar (all)	1		Cypcar (all)	1	
Pass 1	3 (3-3)		Pass 1	1 (1-1)		Pass 1	1		Pass 1	1 (1-1)		Pass 1	1		Pass 1	1		Pass 1	1	
Pass 2	3 (3-3)		Pass 2	1 (1-1)		Pass 2	1 (1-1)		Pass 2	1 (1-1)		Pass 2	1 (1-1)		Pass 2	1 (1-1)		Pass 2	1 (1-1)	
Pass 3	3 (3-3)		Pass 3	1 (1-1)		Pass 3	1 (1-1)		Pass 3	1 (1-1)		Pass 3	1 (1-1)		Pass 3	1 (1-1)		Pass 3	1 (1-1)	
Catlat 411-500	0		Catlat Juvenile	3		Rhiosc (all)	1		Rhiosc (all)	50		Catlat Adult	1		Rhiosc (all)	50		Cypcar Adult	1	
Pass 1	0		Pass 1	3		Pass 1	1		Pass 1	50		Pass 1	1		Pass 1	50		Pass 1	1	
Pass 2	1 (1-1)		Pass 2	3 (3-3)		Pass 2	1 (1-1)		Pass 2	104 (77-141)		Pass 2	1		Pass 2	104 (77-141)		Pass 2	1 (1-1)	
Pass 3	1 (1-1)		Pass 3	3 (3-3)		Pass 3	1 (1-1)		Pass 3	88 (83-95)		Pass 3	1 (1-1)		Pass 3	88 (83-95)		Pass 3	1 (1-1)	
Catlat Adult	0		Catlat 411-500	1		Rhiosc Juvenile	0		Rhiosc Adult	1		Rhiosc Juvenile	0		Rhiosc Adult	1		Rhiosc Adult	49	
Pass 1	0		Pass 1	1 (1-1)		Pass 1	0		Pass 1	1 (1-1)		Pass 1	0		Pass 1	1 (1-1)		Pass 1	49	
Pass 2	3 *		Pass 2	1 (1-1)		Pass 2	1 (1-1)		Pass 2	6 *		Pass 2	104 (77-141)		Pass 2	104 (77-141)		Pass 2	89 (72-113)	
Pass 3	2 (2-15)		Pass 3	1 (1-1)		Pass 3	1 (1-1)		Pass 3	11 *		Pass 3	88 (83-95)		Pass 3	88 (83-95)		Pass 3	87 (81-96)	
Cypcar (all)	6		Catlat 500+	1		Rhiosc Adult	1		Rhiosc Adult	1		Rhiosc Adult	1		Rhiosc Adult	1		Rhiosc Adult	49	
Pass 1	6		Pass 1	1		Pass 1	1		Pass 1	1		Pass 1	1		Pass 1	1		Pass 1	49	
Pass 2	12 (10-12)		Pass 2	1 (1-1)		Pass 2	1 (1-1)		Pass 2	6 *		Pass 2	104 (77-141)		Pass 2	104 (77-141)		Pass 2	89 (72-113)	
Pass 3	11 (11-13)		Pass 3	1 (1-1)		Pass 3	1 (1-1)		Pass 3	11 *		Pass 3	88 (83-95)		Pass 3	88 (83-95)		Pass 3	87 (81-96)	
Cypcar Adult	6		Catlat Adult	1		Catlat Adult	2		Catlat Adult	2		Catlat Adult	2		Catlat Adult	2		Catlat Adult	2	
Pass 1	6		Pass 1	1 (1-1)		Pass 1	2 (2-2)		Pass 1	2		Pass 1	2		Pass 1	2		Pass 1	2	
Pass 2	12 (10-12)		Pass 2	1 (1-1)		Pass 2	2 (2-2)		Pass 2	2 (2-2)		Pass 2	2		Pass 2	2		Pass 2	2	
Pass 3	11 (11-13)		Pass 3	1 (1-1)		Pass 3	2 (2-2)		Pass 3	2 (2-2)		Pass 3	2		Pass 3	2		Pass 3	2	
Ictpun (all)	0		Cypcar (all)	4		Cypcar (all)	2		Cypcar (all)	2		Cypcar (all)	2		Cypcar (all)	2		Cypcar (all)	2	
Pass 1	0		Pass 1	4 (4-4)		Pass 1	2 (2-2)		Pass 1	2		Pass 1	2		Pass 1	2		Pass 1	2	
Pass 2	1 (1-1)		Pass 2	4 (4-4)		Pass 2	2 (2-2)		Pass 2	2 (2-2)		Pass 2	2		Pass 2	2		Pass 2	2	
Pass 3	1 (1-1)		Pass 3	5 (5-6)		Pass 3	2 (2-2)		Pass 3	2 (2-2)		Pass 3	2		Pass 3	2		Pass 3	2	
Ictpun Adult	0		Cypcar Adult	4		Rhiosc (all)	1		Rhiosc (all)	1		Rhiosc (all)	1		Rhiosc (all)	1		Rhiosc (all)	1	
Pass 1	0		Pass 1	4 (4-4)		Pass 1	1 (1-1)		Pass 1	1		Pass 1	1		Pass 1	1		Pass 1	1	
Pass 2	1 (1-1)		Pass 2	4 (4-4)		Pass 2	2 (2-15)		Pass 2	2 (2-15)		Pass 2	1		Pass 2	1		Pass 2	1	
Pass 3	1 (1-1)		Pass 3	5 (5-6)		Pass 3	8 (4-50)		Pass 3	8 (4-50)		Pass 3	8		Pass 3	8		Pass 3	8	
Rhiosc (all)	1		Rhiosc Adult	4 (4-8)		Pass 4	4 (4-8)		Pass 4	4 (4-8)		Pass 4	11 *		Pass 4	11 *		Pass 4	11 *	
Pass 1	1		Pass 1	4 (4-4)		Pass 4	2 (2-15)		Pass 4	2 (2-15)		Pass 4	88 (83-95)		Pass 4	88 (83-95)		Pass 4	87 (81-96)	
Pass 2	2 (2-15)		Pass 2	4 (4-4)		Pass 2	8 (4-50)		Pass 2	8 (4-50)		Pass 2	104 (77-141)		Pass 2	104 (77-141)		Pass 2	89 (72-113)	
Pass 3	8 (4-50)		Pass 3	4 (4-4)		Pass 3	4 (4-8)		Pass 3	4 (4-8)		Pass 3	88 (83-95)		Pass 3	88 (83-95)		Pass 3	87 (81-96)	
Pass 4	4 (4-8)		Pass 4	5 (5-6)		Pass 4	4 (4-8)		Pass 4	4 (4-8)		Pass 4	11 *		Pass 4	11 *		Pass 4	87 (81-96)	

1999 Reach 6 Run Data with Original Breakdowns

Note: an * in the 95% indicates a non-descending removal pattern error

1999 Reach 6			Run, RM 161.0			Run, RM 161.3			Run, RM 164.6		
	Pop. Est.	95% CI		Pop. Est.	95% CI		Pop. Est.	95% CI		Pop. Est.	95% CI
Catlat (all)	3		Catlat (all)	5		Catlat (all)	1		Catlat (all)	1	
Pass 1	3		Pass 1	5		Pass 1	1		Pass 1	1	
Pass 2	5 (5-8)		Pass 2	5 (5-5)		Pass 2	1 (1-1)		Pass 2	1 (1-1)	
Pass 3	5 (5-6)		Pass 3	5 (5-5)		Pass 3	1 (1-1)		Pass 3	1 (1-1)	
Catlat Juvenile	3		Catlat YOY	5		Catlat Adult	1		Catlat Adult	1	
Pass 1	3		Pass 1	5		Pass 1	1		Pass 1	1	
Pass 2	3 (3-3)		Pass 2	1 (1-1)		Pass 2	1 (1-1)		Pass 2	1 (1-1)	
Pass 3	3 (3-3)		Pass 3	1 (1-1)		Pass 3	1 (1-1)		Pass 3	1 (1-1)	
Catlat Adult	0		Catlat Juvenile	3		Rhiosc (all)	1		Rhiosc (all)	1	
Pass 1	0		Pass 1	3		Pass 1	1		Pass 1	1	
Pass 2	3 *		Pass 2	3 (3-3)		Pass 2	8 *		Pass 2	8 *	
Pass 3	2 (2-15)		Pass 3	3 (3-3)		Pass 3	12 *		Pass 3	12 *	
Cypcar (all)	6		Catlat Adult	2		Rhiosc Juvenile	0		Rhiosc Juvenile	0	
Pass 1	6		Pass 1	2 (2-2)		Pass 1	0		Pass 1	0	
Pass 2	12 (10-12)		Pass 2	2 (2-2)		Pass 2	1 (1-1)		Pass 2	1 (1-1)	
Pass 3	11 (11-13)		Pass 3	2 (2-2)		Pass 3	1 (1-1)		Pass 3	1 (1-1)	
Cypcar Adult	6		Cypcar (all)	4		Rhiosc Adult	1		Rhiosc Adult	1	
Pass 1	6		Pass 1	4 (4-4)		Pass 1	1		Pass 1	1	
Pass 2	12 (10-12)		Pass 2	4 (4-4)		Pass 2	6 *		Pass 2	6 *	
Pass 3	11 (11-13)		Pass 3	4 (4-4)		Pass 3	11 *		Pass 3	11 *	
Ictpun (all)	0		Cypcar Adult	4		Rhiosc (all)	1		Rhiosc (all)	1	
Pass 1	0		Pass 1	4 (4-4)		Pass 1	1		Pass 1	1	
Pass 2	1 (1-1)		Pass 2	4 (4-4)		Pass 2	2 (2-15)		Pass 2	2 (2-15)	
Pass 3	1 (1-1)		Pass 3	4 (4-4)		Pass 3	8 (4-50)		Pass 3	8 (4-50)	
Ictpun Adult	0		Rhiosc (all)	1		Pass 4	4 (4-8)		Pass 4	4 (4-8)	
Pass 1	0		Pass 1	1		Pass 4	4 (4-8)		Pass 4	4 (4-8)	
Pass 2	1 (1-1)		Pass 2	2 (2-15)		Pass 1	1		Pass 1	1	
Pass 3	1 (1-1)		Pass 3	8 (4-50)		Pass 2	2 (2-15)		Pass 2	2 (2-15)	
Rhiosc (all)	1		Pass 4	4 (4-8)		Pass 3	8 (4-50)		Pass 3	8 (4-50)	
Pass 1	1		Pass 1	1		Pass 4	4 (4-8)		Pass 4	4 (4-8)	
Pass 2	2 (2-15)		Pass 2	2 (2-15)		Pass 1	1		Pass 1	1	
Pass 3	8 (4-50)		Pass 3	8 (4-50)		Pass 2	2 (2-15)		Pass 2	2 (2-15)	
Pass 4	4 (4-8)		Pass 4	4 (4-8)		Pass 3	8 (4-50)		Pass 3	8 (4-50)	
Rhiosc Adult	1		Pass 1	1		Pass 4	4 (4-8)		Pass 4	4 (4-8)	
Pass 1	1		Pass 2	2 (2-15)		Pass 1	1		Pass 1	1	
Pass 2	2 (2-15)		Pass 3	8 (4-50)		Pass 2	2 (2-15)		Pass 2	2 (2-15)	
Pass 3	8 (4-50)		Pass 4	4 (4-8)		Pass 3	8 (4-50)		Pass 3	8 (4-50)	
Pass 4	4 (4-8)		Pass 1	1		Pass 4	4 (4-8)		Pass 4	4 (4-8)	

1999 Reach 6 Riffle Data with Original Breakdowns

Note: an * in the 95% indicates a non-descending removal pattern error
 1999 Reach 6

		Riffle, RM 161.0				Riffle, RM 162.4				Riffle, RM 165.6	
		Pop. Est.	95% CI			Pop. Est.	95% CI			Pop. Est.	95% CI
Rhiosc (all)				Catlat (all)				Catdis (all)			
	Pass 1	8			Pass 1	1			Pass 1	1	
	Pass 2	8 (8-8)			Pass 2	1 (1-1)			Pass 2	1 (1-1)	
Rhiosc Adult					Pass 3	1 (1-1)			Pass 3	2 (2-15)	
	Pass 1	8		Catlat Juvenile				Catdis Juvenile			
	Pass 2	8 (8-8)			Pass 1	1			Pass 1	1	
					Pass 2	1 (1-1)			Pass 2	1 (1-1)	
					Pass 3	1 (1-1)			Pass 3	2 (2-15)	
				Rhiosc (all)				Cypcar (all)			
					Pass 1	50			Pass 1	1	
					Pass 2	104 (77-141)			Pass 2	1 (1-1)	
					Pass 3	88 (83-95)			Pass 3	1 (1-1)	
				Rhiosc Adult				Cypcar Adult			
					Pass 1	50			Pass 1	1	
					Pass 2	104 (77-141)			Pass 2	1 (1-1)	
					Pass 3	88 (83-95)			Pass 3	1 (1-1)	
								Rhiosc (all)			
									Pass 1	49	
									Pass 2	89 (72-113)	
									Pass 3	87 (81-96)	
								Rhiosc Adult			
									Pass 1	49	
									Pass 2	89 (72-113)	
									Pass 3	87 (81-96)	

1999 Reach 6 Riffle Data with Original Breakdowns

Note: an * in the 95% indicates a non-descending removal pattern error
 1999 Reach 6

		Riffle, RM 161.0				Riffle, RM 162.4				Riffle, RM 165.6	
		Pop. Est.	95% CI			Pop. Est.	95% CI			Pop. Est.	95% CI
Rhiosc (all)				Catlat (all)				Catdis (all)			
	Pass 1	8			Pass 1	1			Pass 1	1	
	Pass 2	8 (8-8)			Pass 2	1 (1-1)			Pass 2	1 (1-1)	
Rhiosc Adult					Pass 3	1 (1-1)			Pass 3	2 (2-15)	
	Pass 1	8		Catlat Juvenile				Catdis Juvenile			
	Pass 2	8 (8-8)			Pass 1	1			Pass 1	1	
					Pass 2	1 (1-1)			Pass 2	1 (1-1)	
					Pass 3	1 (1-1)			Pass 3	2 (2-15)	
				Rhiosc (all)				Cypcar (all)			
					Pass 1	50			Pass 1		
					Pass 2	104 (77-141)			Pass 2		
					Pass 3	88 (83-95)			Pass 3		
				Rhiosc Adult				Cypcar Adult			
					Pass 1	50			Pass 1		
					Pass 2	104 (77-141)			Pass 2		
					Pass 3	88 (83-95)			Pass 3		
								Rhiosc (all)			
									Pass 1	49	
									Pass 2	89 (72-113)	
									Pass 3	87 (81-96)	
								Rhiosc Adult			
									Pass 1	49	
									Pass 2	89 (72-113)	
									Pass 3	87 (81-96)	

1999 Reach 6 Riffle Data with New Catlat and Catdis Breakdowns

Note: an * in the 95% indicates a non-descending removal pattern error
1999 Reach 6

		Riffle, RM 161.0				Riffle, RM 162.4				Riffle, RM 165.6	
		Pop. Est.	95% CI			Pop. Est.	95% CI			Pop. Est.	95% CI
Rhiosc (all)	Pass 1	8		Catlat (all)	Pass 1	1		Catdis (all)	Pass 1	1	
	Pass 2	8 (8-8)			Pass 2	1 (1-1)			Pass 2	1 (1-1)	
Rhiosc Adult	Pass 3	8		Catlat 61-300	Pass 3	1 (1-1)			Pass 3	2 (2-15)	
	Pass 1	8			Pass 1	1		Catdis Juvenile	Pass 1	1	
	Pass 2	8 (8-8)			Pass 2	1 (1-1)			Pass 2	1 (1-1)	
				Rhiosc (all)	Pass 3	1 (1-1)			Pass 3	2 (2-15)	
					Pass 1	50		Cypcar (all)	Pass 1	1	
					Pass 2	104 (77-141)			Pass 2	1 (1-1)	
				Rhiosc Adult	Pass 3	88 (83-95)			Pass 3	1 (1-1)	
					Pass 1	50		Cypcar Adult	Pass 1	1	
					Pass 2	104 (77-141)			Pass 2	1 (1-1)	
					Pass 3	88 (83-95)			Pass 3	1 (1-1)	
								Rhiosc (all)	Pass 1	49	
									Pass 2	89 (72-113)	
									Pass 3	87 (81-96)	
								Rhiosc Adult	Pass 1	49	
									Pass 2	89 (72-113)	
									Pass 3	87 (81-96)	

Reach 7 –

1999 Reach 7 Original and New Catlat and Catdis Breakdowns combined

Note: an * in the 95% indicates a non-descending removal pattern error

1999 Reach 7			Riffle, RM 191.4			Riffle, RM 192.9			Riffle, RM 198.6			Riffle, RM 194.1			Riffle, RM 195.0			Riffle, RM 196-195		
Pop. Est.	95% CI		Pop. Est.	95% CI		Pop. Est.	95% CI		Pop. Est.	95% CI		Pop. Est.	95% CI		Pop. Est.	95% CI		Pop. Est.	95% CI	
Catdis (all)	Pass 1	3		Catdis (all)	Pass 1	4		Catlat (all)	Pass 1	7		Catdis (all)	Pass 1	1		Catdis (all)	Pass 1	19	*	
	Pass 2	4 (4-4)			Pass 2	4 (4-4)			Pass 2	7 (7-7)			Pass 2	1 (1-1)			Pass 2	32	*	
Catdis Juvenile	Pass 3	4 (4-4)			Pass 3	4 (4-4)		Catlat 301-410	Pass 3	7 (7-7)		Catdis Juvenile	Pass 3	1 (1-1)			Pass 3	177	(51-566)	
	Pass 1	3			Pass 1	1			Pass 1	1			Pass 4	8 *			Pass 4	133	(97-231)	
	Pass 2	4 (4-4)			Pass 2	1 (1-1)			Pass 2	1 (1-1)			Pass 1	1		Catdis Juvenile	Pass 1	10		
Rhiosc (all)	Pass 1	3			Pass 3	1 (1-1)		Rhiosc (all)	Pass 1	95		Rhiosc (all)	Pass 1	1 (1-1)			Pass 2	38	(18-73)	
	Pass 2	4 (4-4)			Pass 1	1 (1-1)			Pass 2	116 (113-121)			Pass 2	2 (2-15)			Pass 3	108	(58-700)	
	Pass 3	9 (9-12)		Catdis 301-410	Pass 1	3			Pass 3	65 (61-73)			Pass 3	8 *			Pass 4	119	(56-448)	
Rhiosc Adult	Pass 1	6			Pass 2	3 (3-3)		Catlat Juvenile	Pass 1	1		Rhiosc Adult	Pass 1	100		Catdis 301-410	Pass 1	8	*	
	Pass 2	9 (9-12)			Pass 3	3 (3-3)			Pass 2	1 (1-1)			Pass 2	100 (100-100)			Pass 2	30	*	
	Pass 3	9 (9-12)			Pass 1	3 (3-3)		Catlat 411-500	Pass 1	4			Pass 3	100 (100-100)			Pass 3	56	(26-154)	
					Pass 2	3 (3-3)			Pass 2	0 (4-4)			Pass 4	100 (100-100)			Pass 4	42	(36-48)	
					Pass 3	3 (3-3)			Pass 3	0 (4-4)				100 (100-100)						
					Pass 1	4			Pass 1	2				100 (100-100)						
					Pass 2	4 (4-4)			Pass 2	0 (2-2)				100 (100-100)						
					Pass 3	5 (5-6)			Pass 3	0 (2-2)				100 (100-100)						
					Pass 1	3			Pass 1	6				100 (100-100)						
					Pass 2	0 (3-3)			Pass 2	6 (6-6)				100 (100-100)						
					Pass 3	1 (4-4)			Pass 3	6 (6-6)				100 (100-100)						
					Pass 1	1			Pass 1	33				100 (100-100)						
					Pass 2	0 (1-1)		Rhiosc (all)	Pass 1	115 (58-237)				100 (100-100)						
					Pass 3	0 (1-1)			Pass 2	89 (76-114)				100 (100-100)						
					Pass 1	4			Pass 3	89 (76-114)				100 (100-100)						
					Pass 2	4 (4-4)			Pass 1	33				100 (100-100)						
					Pass 3	5 (5-6)			Pass 2	115 (58-237)				100 (100-100)						
					Pass 1	1			Pass 3	89 (76-114)				100 (100-100)						
					Pass 2	1 (1-1)								100 (100-100)						
					Pass 3	1 (1-1)								100 (100-100)						
					Pass 1	1								100 (100-100)						
					Pass 2	1 (1-1)								100 (100-100)						
					Pass 3	1 (1-1)								100 (100-100)						
					Pass 1	1								100 (100-100)						
					Pass 2	1 (1-1)								100 (100-100)						
					Pass 3	1 (1-1)								100 (100-100)						
					Pass 1	7								100 (100-100)						
					Pass 2	63 (15-487)								100 (100-100)						
					Pass 3	17 (16-22)								100 (100-100)						
					Pass 1	7								100 (100-100)						
					Pass 2	63 (15-487)								100 (100-100)						
					Pass 3	17 (16-22)								100 (100-100)						

1999 Reach 7 Run Data with New Catlat and Catdis Breakdowns

Note: an * in the 95% indicates a non-descending removal pattern error

1999 Reach 7			Run, RM 188.3		Run, RM 191.4		Run, RM 192.9				
		Pop. Est.	95% CI		Pop. Est.	95% CI	Pop. Est.	95% CI			
Catdis (all)	Pass 1	3		Catdis (all)	Pass 1	4		Catlat (all)	Pass 1	7	
	Pass 2	4	(4-6)		Pass 2	4	(4-4)		Pass 2	7	(7-7)
Catdis Juvenile	Pass 1	3		Catdis Juvenile	Pass 3	4	(4-4)	Catlat 301-410	Pass 3	7	(7-7)
	Pass 2	4	(4-6)		Pass 1	1			Pass 1	1	
Rhiosc (all)	Pass 1	6		Catdis 301-410	Pass 2	1	(1-1)		Pass 2	1	(1-1)
	Pass 2	9	(9-12)		Pass 3	1	(1-1)		Pass 3	1	(1-1)
Rhiosc Adult	Pass 1	6		Catlat 411-500	Pass 1	3		Catlat 411-500	Pass 1	4	
	Pass 2	9	(9-12)		Pass 2	3	(3-3)		Pass 2	0	(4-4)
					Pass 3	3	(3-3)		Pass 3	0	(4-4)
				Catlat (all)	Pass 1	4		Catlat 500+	Pass 1	2	
					Pass 2	4	(4-4)		Pass 2	0	(2-2)
					Pass 3	5	(5-6)		Pass 3	0	(2-2)
				Catlat 411-500	Pass 1	3		Catlat Adult	Pass 1	6	
					Pass 2	0	(3-3)		Pass 2	6	(6-6)
					Pass 3	1	(4-6)		Pass 3	6	(6-6)
				Catlat 500+	Pass 1	1		Rhiosc (all)	Pass 1	33	
					Pass 2	0	(1-1)		Pass 2	115	(58-237)
					Pass 3	0	(1-1)		Pass 3	89	(70-114)
				Catlat Adult	Pass 1	4		Rhiosc Adult	Pass 1	33	
					Pass 2	4	(4-4)		Pass 2	115	(58-237)
					Pass 3	5	(5-6)		Pass 3	89	(70-114)
				Pimpro (all)	Pass 1	1					
					Pass 2	1	(1-1)				
					Pass 3	1	(1-1)				
				Pimro Adult	Pass 1	1					
					Pass 2	1	(1-1)				
					Pass 3	1	(1-1)				
				Rhiosc (all)	Pass 1	7					
					Pass 2	63	(15-487)				
					Pass 3	17	(16-22)				
				Rhiosc Adult	Pass 1	7					
					Pass 2	63	(15-487)				
					Pass 3	17	(16-22)				

1999 Reach 7 Rifle Data with Original Breakdowns

Note: an * in the 95% indicates a non-descending removal pattern error

1999 Reach 7			Rifle, RM 188.6		Rifle, RM 194.3		Rifle, RM 195.0				
		Pop. Est.	95% CI		Pop. Est.	95% CI	Pop. Est.	95% CI			
Catdis (all)	Pass 1	2		Catdis (all)	Pass 1	1		Catdis (all)	Pass 1	1	
	Pass 2	2	(2-2)		Pass 2	1	(1-1)		Pass 2	1	(1-1)
Catdis Juvenile	Pass 1	2		Catdis Juvenile	Pass 1	1		Catdis Juvenile	Pass 3	2	(2-15)
	Pass 2	2	(2-2)		Pass 2	1	(1-1)		Pass 4	8	*
Rhiosc (all)	Pass 1	95		Rhiosc (all)	Pass 1	47			Pass 1	1	
	Pass 2	116	(113-121)		Pass 2	65	(61-73)		Pass 2	1	(1-1)
Rhiosc Adult	Pass 1	95		Rhiosc Adult	Pass 1	47			Pass 3	2	(2-15)
	Pass 2	116	(113-121)		Pass 2	65	(61-73)		Pass 4	8	*
								Rhiosc (all)	Pass 1	100	
									Pass 2	100	(100-100)
									Pass 3	100	(100-100)
									Pass 4	100	(100-100)
								Rhiosc Adult	Pass 1	100	
									Pass 2	100	(100-100)
									Pass 3	100	(100-100)
									Pass 4	100	(100-100)

1999 Reach 7 Boat Data with Original Breakdowns

Note: an * in the 95% indicates a non-descending removal pattern error
1999 Reach 7

		Boat, RM 196-195	
		Pop. Est.	95% CI
Catdis (all)	Pass 1	19	
	Pass 2	59	*
	Pass 3	177	(55-566)
	Pass 4	133	(67-251)
Catdis Juvenile	Pass 1	10	
	Pass 2	30	(18-73)
	Pass 3	130	(28-788)
	Pass 4	119	(36-448)
Catdis Adult	Pass 1	9	
	Pass 2	32	*
	Pass 3	50	(27-115)
	Pass 4	42	(31-65)
Catlat (all)	Pass 1	53	
	Pass 2	171	(91-301)
	Pass 3	153	(113-195)
	Pass 4	168	(135-201)
Catlat Juvenile	Pass 1	5	
	Pass 2	17	(10-53)
	Pass 3	11	(11-14)
	Pass 4	21	(15-40)
Catlat Adult	Pass 1	48	
	Pass 2	141	(81-238)
	Pass 3	140	(102-182)
	Pass 4	144	(117-171)
Rhiosc (all)	Pass 1	2	
	Pass 2	4	(4-9)
	Pass 3	4	(4-6)
	Pass 4	4	(4-5)
Rhiosc Adult	Pass 1	2	
	Pass 2	4	(4-9)
	Pass 3	4	(4-6)
	Pass 4	4	(4-5)
Saltru (all)	Pass 1	1	
	Pass 2	2	(2-15)
	Pass 3	8	(4-50)
	Pass 4	7	(5-23)
Saltru Juvenile	Pass 1	1	
	Pass 2	1	(1-1)
	Pass 3	2	(2-15)
	Pass 4	2	(2-9)
Saltru Adult	Pass 1	0	
	Pass 2	1	(1-1)
	Pass 3	2	(2-26)
	Pass 4	6	(3-46)

1999 Reach 7 Boat Data with New Catlat and Catdis Breakdowns

Note: an * in the 95% indicates a non-descending removal pattern error
1999 Reach 7

		Boat, RM 196-195	
		Pop. Est.	95% CI
Catdis (all)	Pass 1	19	
	Pass 2	59	*
	Pass 3	177	(55-566)
	Pass 4	133	(67-251)
Catdis Juvenile	Pass 1	10	
	Pass 2	30	(18-73)
	Pass 3	130	(28-788)
	Pass 4	119	(36-448)
Catdis 301-410	Pass 1	8	
	Pass 2	30	*
	Pass 3	56	(26-154)
	Pass 4	42	(30-68)
Catdis 411-501	Pass 1	1	
	Pass 2	1	(1-1)
	Pass 3	1	(1-1)
	Pass 4	1	(1-1)
Catdis Adult	Pass 1	9	
	Pass 2	32	*
	Pass 3	50	(27-115)
	Pass 4	42	(31-65)
Catlat (all)	Pass 1	53	
	Pass 2	171	(91-301)
	Pass 3	153	(113-195)
	Pass 4	168	(135-201)
Catlat Juvenile	Pass 1	5	
	Pass 2	17	(10-53)
	Pass 3	11	(11-14)
	Pass 4	21	(15-40)
Catlat 411-500	Pass 1	42	
	Pass 2	153	(74-309)
	Pass 3	143	(95-202)
	Pass 4	132	(107-158)
Catlat 500+	Pass 1	6	
	Pass 2	7	(7-8)
	Pass 3	7	(7-7)
	Pass 4	8	(8-9)
Catlat Adult	Pass 1	48	
	Pass 2	141	(81-238)
	Pass 3	140	(102-182)
	Pass 4	144	(117-171)
Rhiosc (all)	Pass 1	2	
	Pass 2	4	(4-9)
	Pass 3	4	(4-6)
	Pass 4	4	(4-5)
Rhiosc Adult	Pass 1	2	
	Pass 2	4	(4-9)
	Pass 3	4	(4-6)
	Pass 4	4	(4-5)
Saltru (all)	Pass 1	1	
	Pass 2	2	(2-15)
	Pass 3	8	(4-50)
	Pass 4	7	(5-23)
Saltru Juvenile	Pass 1	1	
	Pass 2	1	(1-1)
	Pass 3	2	(2-15)
	Pass 4	2	(2-9)
Saltru Adult	Pass 1	0	
	Pass 2	1	(1-1)
	Pass 3	2	(2-26)
	Pass 4	6	(3-46)

Population estimate results- 2000: Reach 3 –

2000 Reach 3 Boat and Habitat Original Breakdowns

Note: A * in the 95% CI indicates a non-descending removal pattern error

2000 Sand Island	Riffle #1		Riffle #2		Riffle #3		Run #1		Run #2		Run #3		Boat	
	Pop. Est.	95% CI	Pop. Est.	95% CI	Pop. Est.	95% CI	Pop. Est.	95% CI	Pop. Est.	95% CI	Pop. Est.	95% CI	Pop. Est.	95% CI
Cyplut ADT	1	(1, 1)	Callat JUV	1 (1, 1)	Callat JUV	3 (3, 6)	Callat JUV	9 (8, 9)	Callat JUV	1 (1, 1)	Callat JUV	2 (2, 2)	Callat ADT	2 (2, 2)
Rhosc ADT	61	(61, 62)	Cyplut ADT	1	Callat JUV	2 (2, 2)	Cyplut (all)	16 (12, 31)	Cyplut (all)	26 (18, 50)	Cyplut (all)	9	Callat (all)	105 (70, 155)
			Total	2	Cyplut ADT	1	Cyplut ADT	13 (5, 95)	Cyplut ADT	27 (17, 60)	Total	7	Callat ADT	49 (34, 80)
			Icipun (all)	2	Lapcya YOY	1 (1, 1)	Cyplut JUV	7 (7, 9)	Cyplut JUV	1 (1, 1)	Cyplut JUV	2 (2, 2)	Cyplut JUV	51 (36, 81)
			Icipun JUV	1	Rhosc ADT	43 (42, 47)	Icipun JUV	6 (6, 8)	Icipun JUV	7 (7, 8)	Icipun (all)	5 (5, 5)	Cyplut ADT	43 (37, 54)
			Icipun YOY	1			Rhosc ADT	8 (8, 10)	Icipun YOY	2 (2, 2)	Icipun JUV	2 (2, 2)	Icipun (all)	279 (248, 310)
			Rhosc ADT	87 (87, 88)					Rhosc ADT	11 (11, 13)	Icipun YOY	3 (3, 3)	Icipun ADT	35 (32, 42)
											Lapcya YOY	1	Icipun JUV	243 (213, 273)
											Total	2		
											Rhosc ADT	2 (2, 2)		

Population estimate results- 2001: Reach 3 –

2001 Reach 3 Boat and Habitat Original Breakdowns

Note: A * in the 95% CI indicates a non-descending removal pattern error

2001 Sand Island		Rifle #1 RM 81		Rifle #2 RM 79		Rifle #3 RM 77		Run #1 RM 82		Run #2 RM 80		Run #3 RM 78		Boat	
Pop. Est.	95% CI	Pop. Est.	95% CI	Pop. Est.	95% CI	Pop. Est.	95% CI	Pop. Est.	95% CI	Pop. Est.	95% CI	Pop. Est.	95% CI	Pop. Est.	95% CI
Cyphat (all)	14 (14, 14)	Calhat JUV	1 (1, 1)	Cyphat ADT	9 (9, 10)	Calhat JUV	3 (3, 3)	Calhat JUV	1 (1, 1)	Calhat JUV	8 (8, 9)	Calhat ADT	80 (88, 94)	Calhat ADT	29 (24, 41)
Cyphat ADT	13 (13, 13)	Cyphat (all)	21 (21, 23)	lctpun JUV	1 (1, 1)	Cyphat ADT	22 (20, 29)	Cyphat (all)	103 (67, 155)	Cyphat ADT	103 (67, 155)	Cyphat ADT	77 (69, 88)	Cyphat ADT	8 (8, 8)
Cyphat JUV	1 (1, 1)	Cyphat ADT	20 (20, 22)	Rhiose (all)	36 (36, 37)	lctpun (all)	28 (28, 29)	lctpun (all)	92 (49, 178)	lctpun (all)	118 (106, 131)	lctpun (all)	118 (106, 131)	lctpun (all)	16 Total
lctpun JUV	2 (2, 2)	Cyphat JUV	1 (1, 1)	Rhiose ADT	30 (30, 30)	lctpun JUV	11 (11, 11)	lctpun JUV	19 (18, 24)	lctpun JUV	19 (18, 24)	lctpun JUV	77 (69, 88)	lctpun JUV	318 (142, 557)
Rhiose (all)	79 (79, 79)	Pimpro ADT	1 (1, 1)	Rhiose JUV	6 (6, 6)	lctpun YOY	17 (17, 18)	lctpun YOY	66 (56, 81)	lctpun YOY	40 (37, 47)	lctpun YOY	40 (37, 47)	lctpun YOY	44 Total
Rhiose ADT	62 (62, 62)	Rhiose (all)	122 (122, 123)			Rhiose ADT	20 (19, 24)	Rhiose ADT	57 (41, 86)	Rhiose ADT	2 (2, 15)	Rhiose ADT	2 (2, 15)	Calhat JUV	174 (98, 275)
Rhiose JUV	17 (17, 17)	Rhiose ADT	115 (115, 115)						lctpun YOY	15 (15, 16)				Cyphat (all)	24 Total
		Rhiose JUV	7 (7, 8)						Pimpro ADT	3 (3, 8)				Cyphat ADT	23 Total
									Rhiose (all)	23 (22, 27)				Cyphat JUV	1 Total
									Rhiose ADT	22 (21, 26)				lctpun (all)	130 Total
									Rhiose JUV	1 (1, 1)				lctpun ADT	23 Total
														lctpun JUV	107 Total

Reach 6 –

2001 Reach 6 Boat and Habitat Original Breakdowns

Note: A * in the 95% CI indicates a non-descending removal pattern error

2001 Hatch Trading		Rifle #1 RM 177.5		Rifle #2 RM 172		Rifle #3 RM 168		Run #1 RM 176.5		Run #2 RM 174		Run #4 RM 171B		Boat	
Pop. Est.	95% CI	Pop. Est.	95% CI	Pop. Est.	95% CI	Pop. Est.	95% CI	Pop. Est.	95% CI	Pop. Est.	95% CI	Pop. Est.	95% CI	Pop. Est.	95% CI
Cadns (all)	2	Calhat (all)	1	Pimpro (all)	1	Cadns (all)	8	Cadns (all)	17	Cadns (all)	5	Cadns (all)	163	Cadns (all)	163
Pass 1	2 (2, 2)	Pass 1	1 (1, 1)	Pass 1	1 (1, 1)	Pass 1	9 (9, 10)	Pass 1	17 (17, 17)	Pass 1	5 (5, 5)	Pass 1	640 (286, 1616)	Pass 1	640 (286, 1616)
Pass 2	3 (3, 6)	Pass 2	1 (1, 1)	Pass 2	1 (1, 1)	Pass 2	11 (11, 13)	Pass 2	18 (18, 18)	Pass 2	5 (5, 5)	Pass 2	508 (417, 599)	Pass 2	508 (417, 599)
Pass 3	3 (3, 6)	Pass 3	1 (1, 1)	Pass 3	1 (1, 1)	Pass 3	4 (4, 4)	Pass 3	12 (12, 12)	Pass 3	4 (4, 4)	Pass 3	474 (434, 514)	Pass 3	474 (434, 514)
Cadns JUV	2	Calhat YOY	1	Pimpro ADT	1	Cadns YOY	4	Cadns YOY	12 (12, 13)	Cadns YOY	4	Cadns YOY	150	Cadns JUV	150
Pass 1	2 (2, 2)	Pass 1	1 (1, 1)	Pass 1	1 (1, 1)	Pass 1	4 (4, 4)	Pass 1	12 (12, 13)	Pass 1	4 (4, 4)	Pass 1	666 (268, 1148)	Pass 1	666 (268, 1148)
Pass 2	3 (3, 6)	Pass 2	1 (1, 1)	Pass 2	1 (1, 1)	Pass 2	4 (4, 4)	Pass 2	13 (13, 13)	Pass 2	4 (4, 4)	Pass 2	892 (394, 590)	Pass 2	892 (394, 590)
Pass 3	3 (3, 6)	Pass 3	1 (1, 1)	Pass 3	1 (1, 1)	Pass 3	6 (6, 10)	Pass 3	5 (5, 5)	Pass 3	1 (1, 1)	Pass 3	451 (409, 493)	Pass 3	451 (409, 493)
Calhat (all)	2	Pimpro (all)	2	Rhiose (all)	282	Cadns JUV	3	Calhat JUV	5	Calhat ADT	1	Calhat ADT	19 (18, 24)	Calhat ADT	19 (18, 24)
Pass 1	1 (1, 1)	Pass 1	2 (2, 2)	Pass 1	325 (320, 331)	Pass 1	4 (4, 4)	Pass 1	5 (5, 5)	Pass 1	1 (1, 1)	Pass 1	22 (21, 26)	Pass 1	22 (21, 26)
Pass 2	1 (1, 1)	Pass 2	2 (2, 2)	Pass 2	325 (325, 327)	Pass 2	6 (6, 10)	Pass 2	5 (5, 5)	Pass 2	1 (1, 1)	Pass 2	23 (23, 25)	Pass 2	23 (23, 25)
Pass 3	1 (1, 1)	Pass 3	2 (2, 2)	Pass 3	3	Pass 3	1 (1, 1)	Pass 3	27 (27, 28)	Pass 3	21 (21, 23)	Pass 3	22 (22, 23)	Pass 3	22 (22, 23)
Calhat JUV	2	Pimpro ADT	2	Rhiose ADT	282	Calhat YOY	7	Calhat YOY	25 (25, 26)	Calhat YOY	22	Calhat YOY	210 (141, 2735)	Calhat YOY	210 (141, 2735)
Pass 1	1 (1, 1)	Pass 1	2 (2, 2)	Pass 1	325 (325, 327)	Pass 1	8 (8, 9)	Pass 1	25 (25, 26)	Pass 1	20 (20, 22)	Pass 1	1162 (815, 1509)	Pass 1	1162 (815, 1509)
Pass 2	1 (1, 1)	Pass 2	2 (2, 2)	Pass 2	3	Pass 2	8 (8, 8)	Pass 2	25 (25, 25)	Pass 2	21 (21, 22)	Pass 2	851 (772, 934)	Pass 2	851 (772, 934)
Pass 3	1 (1, 1)	Pass 3	2 (2, 2)	Pass 3	2 (2, 15)	Pass 3	7 (7, 7)	Pass 3	29 (29, 30)	Pass 3	22 (22, 23)	Pass 3	1285 (441, 2735)	Pass 3	1285 (441, 2735)
Pimpro (all)	2	Rhiose (all)	145	Rhiose ADT	145	Pimpro ADT	7	Cadns JUV	2	Cadns JUV	1	Cadns JUV	1447 (809, 2883)	Cadns JUV	1447 (809, 2883)
Pass 1	2 (2, 2)	Pass 1	161 (160, 164)	Pass 1	161 (160, 164)	Pass 1	8 (8, 9)	Pass 1	2 (2, 2)	Pass 1	1 (1, 1)	Pass 1	947 (707, 1187)	Pass 1	947 (707, 1187)
Pass 2	2 (2, 2)	Pass 2	167 (167, 169)	Pass 2	167 (167, 169)	Pass 2	8 (8, 8)	Pass 2	2 (2, 2)	Pass 2	1 (1, 1)	Pass 2	770 (696, 844)	Pass 2	770 (696, 844)
Pass 3	1 (1, 1)	Pass 3	2 (2, 2)	Pass 3	2 (2, 2)	Pass 3	8 (8, 8)	Pass 3	4 (4, 9)	Pass 3	1 (1, 1)	Pass 3	84 *	Pass 3	84 *
Pimpro AD	2	Rhiose ADT	145	Rhiose JUV	145	Pimpro ADT	7	Pimpro ADT	38 (45, 45)	Pimpro ADT	3	Pimpro ADT	19 (19, 19)	Pimpro ADT	19 (19, 19)
Pass 1	2 (2, 2)	Pass 1	161 (160, 164)	Pass 1	161 (160, 164)	Pass 1	8 (8, 9)	Pass 1	45 (45, 46)	Pass 1	3 (3, 3)	Pass 1	49 (32, 90)	Pass 1	49 (32, 90)
Pass 2	2 (2, 2)	Pass 2	167 (167, 169)	Pass 2	167 (167, 169)	Pass 2	8 (8, 8)	Pass 2	4 (4, 6)	Pass 2	4 (4, 6)	Pass 2	84 *	Pass 2	84 *
Pass 3	2 (2, 2)	Pass 3	2 (2, 2)	Pass 3	2 (2, 2)	Pass 3	7 (7, 7)	Pass 3	15 (15, 15)	Pass 3	1 (1, 1)	Pass 3	10 (10, 12)	Pass 3	10 (10, 12)
Rhiose (all)	112	Cobai (all)	2	Rhiose ADT	149 (154, 417)	Rhiose ADT	6	Pimpro JUV	18 (18, 20)	Pimpro JUV	1	Pimpro JUV	19 (15, 32)	Pimpro JUV	15 (15, 17)
Pass 1	112 (120, 122)	Pass 1	2 (2, 2)	Pass 1	149 (149, 154)	Pass 1	7 (7, 7)	Pass 1	20 (20, 22)	Pass 1	1 (1, 1)	Pass 1	3 (3, 6)	Pass 1	3 (3, 6)
Pass 2	120 (120, 122)	Pass 2	2 (2, 2)	Pass 2	149 (149, 154)	Pass 2	9 *	Pass 2	15 (15, 15)	Pass 2	1 (1, 1)	Pass 2	14 (14, 14)	Pass 2	14 (14, 14)
Pass 3	123 (123, 124)	Pass 3	2 (2, 2)	Pass 3	149 (149, 154)	Pass 3	6 (6, 10)	Pass 3	18 (18, 20)	Pass 3	1 (1, 1)	Pass 3	22 (22, 23)	Pass 3	22 (22, 23)
Rhiose ADT	112	Cobai JUV	2	Rhiose ADT	149 (154, 417)	Rhiose ADT	6	Pimpro ADT	20 (20, 22)	Pimpro ADT	1	Pimpro ADT	19 (19, 19)	Pimpro ADT	19 (19, 19)
Pass 1	112 (120, 122)	Pass 1	2 (2, 2)	Pass 1	149 (149, 154)	Pass 1	29	Pass 1	23 (23, 25)	Pass 1	2 (2, 2)	Pass 1	14 (14, 14)	Pass 1	14 (14, 14)
Pass 2	120 (120, 122)	Pass 2	2 (2, 2)	Pass 2	149 (149, 154)	Pass 2	149 (154, 417)	Pass 2	25 (25, 26)	Pass 2	2 (2, 2)	Pass 2	22 (22, 23)	Pass 2	22 (22, 23)
Pass 3	123 (123, 124)	Pass 3	2 (2, 2)	Pass 3	149 (149, 154)	Pass 3	64 (58, 74)	Pass 3	25 (25, 25)	Pass 3	3 (3, 6)	Pass 3	5 (5, 7)	Pass 3	5 (5, 7)
Rhiose JUV	1	Cobai ADT	2	Rhiose ADT	149 (154, 417)	Rhiose ADT	64 (58, 74)	Rhiose ADT	43 (43, 43)	Rhiose ADT	14	Rhiose ADT	19 (19, 19)	Rhiose ADT	19 (19, 19)
Pass 1	1 (1, 1)	Pass 1	2 (2, 2)	Pass 1	149 (149, 154)	Pass 1	60 (56, 68)	Pass 1	60 (56, 68)	Pass 1	22 (20, 29)	Pass 1	5 (5, 8)	Pass 1	5 (5, 8)
Pass 2	1 (1, 1)	Pass 2	2 (2, 2)	Pass 2	149 (149, 154)	Pass 2	61 (60, 64)	Pass 2	41 (40, 44)	Pass 2	26 (24, 32)	Pass 2	5 (5, 7)	Pass 2	5 (5, 7)
Pass 3	1 (1, 1)	Pass 3	2 (2, 2)	Pass 3	149 (149, 154)	Pass 3	7 (7, 7)	Pass 3	15 (15, 15)	Pass 3	1 (1, 1)	Pass 3	7 (7, 9)	Pass 3	7 (7, 9)
Rhiose ADT	1	Cobai JUV	2	Rhiose ADT	149 (154, 417)	Rhiose ADT	7 (7, 7)	Rhiose ADT	11 (11, 13)	Rhiose ADT	2 (2, 15)	Rhiose ADT	12 (10, 12)	Rhiose ADT	12 (10, 12)
Pass 1	1 (1, 1)	Pass 1	2 (2, 2)	Pass 1	149 (149, 154)	Pass 1	9	Pass 1	11 (11, 11)	Pass 1	2 (2, 15)	Pass 1	10 (10, 12)	Pass 1	10 (10, 12)
Pass 2	1 (1, 1)	Pass 2	2 (2, 2)	Pass 2	149 (149, 154)	Pass 2	9 *	Pass 2	11 (11, 13)	Pass 2	1 (1, 1)	Pass 2	0	Pass 2	0
Pass 3	1 (1, 1)	Pass 3	2 (2, 2)	Pass 3	149 (149, 154)	Pass 3	6 (6, 10)	Pass 3	11 (11, 11)	Pass 3	1 (1, 1)	Pass 3	1 (1, 1)	Pass 3	1 (1, 1)
Rhiose ADT	1	Cobai ADT	2	Rhiose ADT	149 (154, 417)	Rhiose ADT	6 (6, 10)	Rhiose ADT	34 (35, 35)	Rhiose ADT	19 (18, 24)	Rhiose ADT	1 (1, 1)	Pass 4	1 (1, 1)
Pass 1	1 (1, 1)	Pass 1	2 (2, 2)	Pass 1	149 (149, 154)	Pass 1	29	Pass 1	48 (48, 55)	Pass 1	24 (22, 30)	Pass 1	1 (1, 1)	Pass 4	1 (1, 1)
Pass 2	1 (1, 1)	Pass 2	2 (2, 2)	Pass 2	149 (149, 154)	Pass 2	149 (154, 417)	Pass 2	50 (49, 55)	Pass 2	13	Pass 2	1 (1, 1)	Pass 4	1 (1, 1)
Pass 3	1 (1, 1)	Pass 3	2 (2, 2)	Pass 3	149 (149, 154)	Pass 3	64 (58, 74)	Pass 3	50 (49, 55)	Pass 3	19 (18, 24)	Pass 3	2 (2, 26)	Pass 4	2 (2, 26)
Rhiose ADT	1	Cobai JUV	2	Rhiose ADT	149 (154, 417)	Rhiose ADT	64 (58, 74)	Rhiose ADT	50 (49, 55)	Pass 4	1 (1, 1)	Pass 4	1 (1, 1)	Pass 4	1 (1, 1)
Pass 1	1 (1, 1)	Pass 1	2 (2, 2)	Pass 1	149 (149, 154)	Pass 1	29	Pass 1	50 (49, 55)	Pass 4	1 (1, 1)	Pass 4	1 (1, 1)	Pass 4	1 (1, 1)
Pass 2	1 (1, 1)	Pass 2	2 (2, 2)	Pass 2	149 (149, 154)	Pass 2	149 (154, 417)	Pass 2	50 (49, 55)	Pass 4	1 (1, 1)	Pass 4	1 (1, 1)	Pass 4	1 (1, 1)
Pass 3	1 (1, 1)	Pass 3	2 (2, 2)	Pass 3	149 (149, 154)	Pass 3	64 (58, 74)	Pass 3	50 (49, 55)	Pass 4	1 (1, 1)	Pass 4	1 (1, 1)	Pass 4	1 (1, 1)
Rhiose ADT	1	Cobai ADT	2	Rhiose ADT	149 (154, 417)	Rhiose ADT	64 (58, 74)	Rhiose ADT	50 (49, 55)	Pass 4	1 (1, 1)	Pass 4	1 (1, 1)	Pass 4	1 (1, 1)
Pass 1	1 (1, 1)	Pass 1	2 (2, 2)	Pass 1	149 (149, 154)	Pass 1	29	Pass 1	50 (49, 55)	Pass 4	1 (1, 1)	Pass 4	1 (1, 1)	Pass 4	1 (1, 1)
Pass 2	1 (1, 1)	Pass 2	2 (2, 2)	Pass 2	149 (149, 154)	Pass 2	149 (154, 417)	Pass 2	50 (49, 55)	Pass 4	1 (1, 1)	Pass 4	1 (1, 1)	Pass 4	1 (1, 1)
Pass 3</															

2001 Reach 4 Base and Habitat Original Breakdowns

Note: A * in the 95% CI indicates a non-descending removal pattern error

2001 Hatch Training Pool			Riffle #1 BSM 171			Riffle #2 BSM 172			Riffle #3 BSM 188			Run #1 BSM 176			Run #2 BSM 174			Run #3 BSM 178			Run #4 BSM 170						
Pass	Est.	95% CI	Pass	Est.	95% CI	Pass	Est.	95% CI	Pass	Est.	95% CI	Pass	Est.	95% CI	Pass	Est.	95% CI	Pass	Est.	95% CI	Pass	Est.	95% CI				
Catdis (all)	Pass 1	2	(2, 2)	Catlat (all)	Pass 1	1	(1, 1)	Pimpro (all)	Pass 1	1	(1, 1)	Catdis (all)	Pass 1	8	(8, 88)	Catdis (all)	Pass 1	17	(17, 17)	Catdis (all)	Pass 1	5	(5, 5)	Catdis (all)	Pass 1	5	(5, 5)
	Pass 2	3	(3, 4)		Pass 2	1	(1, 1)		Pass 2	1	(1, 1)		Pass 2	17	(17, 17)		Pass 2	17	(17, 17)		Pass 2	5	(5, 5)		Pass 2	5	(5, 5)
	Pass 3	1	(1, 1)		Pass 3	1	(1, 1)		Pass 3	1	(1, 1)		Pass 3	18	(18, 18)		Pass 3	18	(18, 18)		Pass 3	5	(5, 5)		Pass 3	5	(5, 5)
Catdis JUV	Pass 1	2	(2, 2)	Catdis YOY	Pass 1	1	(1, 1)	Pimpro ADT	Pass 1	1	(1, 1)	Catdis YOY	Pass 1	12	(12, 12)	Catdis YOY	Pass 1	4	(4, 4)	Catdis YOY	Pass 1	4	(4, 4)	Catdis JUV	Pass 1	150	(150, 150)
	Pass 2	2	(2, 2)		Pass 2	1	(1, 1)		Pass 2	1	(1, 1)		Pass 2	12	(12, 12)		Pass 2	4	(4, 4)		Pass 2	4	(4, 4)		Pass 2	466	(238, 1148)
	Pass 3	1	(1, 1)		Pass 3	1	(1, 1)		Pass 3	1	(1, 1)		Pass 3	13	(13, 13)		Pass 3	4	(4, 4)		Pass 3	1	(1, 1)		Pass 3	452	(164, 154)
Catlat (all)	Pass 1	1	(1, 1)	Pimpro (all)	Pass 1	2	(2, 2)	Rhiosc (all)	Pass 1	282	(120, 333)	Catdis JUV	Pass 1	3	(4, 4)	Catdis JUV	Pass 1	5	(5, 5)	Catdis JUV	Pass 1	1	(1, 1)	Catdis ADT	Pass 1	13	(13, 13)
	Pass 2	1	(1, 1)		Pass 2	2	(2, 2)		Pass 2	325	(121, 327)		Pass 2	4	(4, 4)		Pass 2	5	(5, 5)		Pass 2	1	(1, 1)		Pass 2	1	(1, 1)
	Pass 3	1	(1, 1)		Pass 3	2	(2, 2)		Pass 3	3	(2, 15)		Pass 3	1	(1, 1)		Pass 3	5	(5, 5)		Pass 3	1	(1, 1)		Pass 3	1	(1, 1)
Catlat JUV	Pass 1	1	(1, 1)	Pimpro ADT	Pass 1	2	(2, 2)	Rhiosc Juv	Pass 1	3	*	Catdis ADT	Pass 1	1	(1, 1)	Catlat (all)	Pass 1	25	(27, 28)	Catlat (all)	Pass 1	17	(17, 17)	Catlat ADT	Pass 1	13	(13, 13)
	Pass 2	1	(1, 1)		Pass 2	2	(2, 2)		Pass 2	3	*		Pass 2	27	(27, 28)		Pass 2	27	(27, 28)		Pass 2	21	(21, 21)		Pass 2	22	(22, 22)
	Pass 3	1	(1, 1)		Pass 3	2	(2, 2)		Pass 3	2	(2, 15)		Pass 3	1	(1, 1)		Pass 3	29	(29, 30)		Pass 3	22	(22, 22)		Pass 3	22	(22, 22)
Pimpro (all)	Pass 1	2	(2, 2)	Rhiosc (all)	Pass 1	185	(168, 184)	Rhiosc ADT	Pass 1	282	(120, 333)	Pimpro (all)	Pass 1	7	(7, 7)	Catdis YOY	Pass 1	23	(23, 26)	Catdis YOY	Pass 1	36	(36, 36)	Catlat (all)	Pass 1	16	(16, 16)
	Pass 2	2	(2, 2)		Pass 2	185	(168, 184)		Pass 2	325	(120, 333)		Pass 2	8	(8, 8)		Pass 2	25	(25, 26)		Pass 2	20	(20, 22)		Pass 2	20	(20, 22)
	Pass 3	2	(2, 2)		Pass 3	187	(167, 189)		Pass 3	325	(120, 327)		Pass 3	8	(8, 8)		Pass 3	20	(20, 22)		Pass 3	4	(4, 4)		Pass 3	21	(21, 22)
Pimpro ADT	Pass 1	2	(2, 2)	Rhiosc ADT	Pass 1	185	(168, 184)	Pimpro ADT	Pass 1	1	(1, 1)	Pimpro ADT	Pass 1	2	(2, 2)	Catlat JUV	Pass 1	2	(2, 2)	Catlat JUV	Pass 1	1	(1, 1)	Catlat JUV	Pass 1	1	(1, 1)
	Pass 2	2	(2, 2)		Pass 2	185	(168, 184)		Pass 2	8	(8, 8)		Pass 2	2	(2, 2)		Pass 2	43	(43, 43)		Pass 2	3	(3, 3)		Pass 2	3	(3, 3)
	Pass 3	2	(2, 2)		Pass 3	187	(167, 189)		Pass 3	8	(8, 8)		Pass 3	4	(4, 4)		Pass 3	45	(45, 46)		Pass 3	4	(4, 4)		Pass 3	4	(4, 4)
Rhiosc (all)	Pass 1	112	(120, 122)	Catlat (all)	Pass 1	2	(2, 2)	Rhiosc (all)	Pass 1	30	(30, 30)	Pimpro (all)	Pass 1	38	(38, 38)	Pimpro (all)	Pass 1	38	(38, 38)	Pimpro (all)	Pass 1	1	(1, 1)	Catlat ADT	Pass 1	8	(8, 8)
	Pass 2	129	(123, 134)		Pass 2	2	(2, 2)		Pass 2	90	(90, 90)		Pass 2	43	(43, 43)		Pass 2	43	(43, 43)		Pass 2	3	(3, 3)		Pass 2	99	(12, 90)
	Pass 3	123	(123, 124)		Pass 3	2	(2, 2)		Pass 3	73	(64, 81)		Pass 3	73	(64, 81)		Pass 3	45	(45, 46)		Pass 3	4	(4, 4)		Pass 3	49	(49, 49)
Rhiosc ADT	Pass 1	112	(120, 122)	Catlat JUV	Pass 1	2	(2, 2)	Rhiosc Juv	Pass 1	1	(1, 1)	Pimpro JUV	Pass 1	15	(15, 15)	Pimpro JUV	Pass 1	15	(15, 15)	Pimpro JUV	Pass 1	1	(1, 1)	Catlat ADT	Pass 1	84	(84, 84)
	Pass 2	129	(120, 132)		Pass 2	2	(2, 2)		Pass 2	9	*		Pass 2	18	(18, 20)		Pass 2	18	(18, 20)		Pass 2	1	(1, 1)		Pass 2	8	(8, 8)
	Pass 3	123	(123, 124)		Pass 3	2	(2, 2)		Pass 3	6	(6, 9)		Pass 3	20	(20, 22)		Pass 3	20	(20, 22)		Pass 3	1	(1, 1)		Pass 3	81	(18, 113)
	Pass 1	112	(120, 122)		Pass 1	2	(2, 2)	Rhiosc ADT	Pass 1	29	(29, 29)	Pimpro ADT	Pass 1	23	(23, 26)	Pimpro ADT	Pass 1	2	(2, 2)	Pimpro ADT	Pass 1	2	(2, 2)	Cypsel (all)	Pass 1	8	(8, 8)
	Pass 2	129	(120, 132)		Pass 2	2	(2, 2)		Pass 2	149	(148, 147)		Pass 2	25	(25, 26)		Pass 2	2	(2, 2)		Pass 2	2	(2, 2)		Pass 2	39	(10, 12)
	Pass 3	123	(123, 124)		Pass 3	2	(2, 2)		Pass 3	64	(18, 70)		Pass 3	3	(3, 3)		Pass 3	1	(1, 1)		Pass 3	1	(1, 1)		Pass 3	15	(15, 17)
	Pass 1	43	(43, 43)		Pass 1	14	(14, 14)	Rhiosc (all)	Pass 1	66	(56, 84)	Rhiosc (all)	Pass 1	14	(14, 14)	Rhiosc (all)	Pass 1	14	(14, 14)	Rhiosc (all)	Pass 1	3	(3, 3)	Cypsel ADT	Pass 1	5	(5, 5)
	Pass 2	60	(56, 64)		Pass 2	22	(20, 28)		Pass 2	60	(56, 64)		Pass 2	22	(20, 28)		Pass 2	22	(20, 28)		Pass 2	2	(2, 2)		Pass 2	7	(7, 7)
	Pass 3	61	(58, 64)		Pass 3	26	(24, 27)		Pass 3	64	(18, 70)		Pass 3	26	(24, 27)		Pass 3	26	(24, 27)		Pass 3	5	(5, 5)		Pass 3	5	(5, 5)
Rhiosc Juv	Pass 1	9	(9, 9)	Rhiosc Juv	Pass 1	1	(1, 1)	Rhiosc Juv	Pass 1	1	(1, 1)	Rhiosc Juv	Pass 1	1	(1, 1)	Rhiosc Juv	Pass 1	1	(1, 1)	Rhiosc Juv	Pass 1	1	(1, 1)	Cypsel ADT	Pass 1	5	(5, 5)
	Pass 2	11	(11, 11)		Pass 2	2	(2, 2)		Pass 2	11	(11, 11)		Pass 2	2	(2, 2)		Pass 2	2	(2, 2)		Pass 2	2	(2, 2)		Pass 2	12	(7, 9)
	Pass 3	11	(11, 11)		Pass 3	2	(2, 2)		Pass 3	11	(11, 11)		Pass 3	2	(2, 2)		Pass 3	2	(2, 2)		Pass 3	2	(2, 2)		Pass 3	12	(10, 12)
Rhiosc ADT	Pass 1	34	(43, 51)	Rhiosc ADT	Pass 1	47	(73, 84)	Rhiosc ADT	Pass 1	47	(73, 84)	Rhiosc ADT	Pass 1	47	(73, 84)	Rhiosc ADT	Pass 1	47	(73, 84)	Rhiosc ADT	Pass 1	13	(18, 24)	Iqoop (all)	Pass 1	0	(0, 0)
	Pass 2	48	(43, 51)		Pass 2	74	(65, 88)		Pass 2	74	(65, 88)		Pass 2	74	(65, 88)		Pass 2	31	(14, 118)		Pass 2	19	(18, 24)		Pass 2	1	(1, 1)
	Pass 3	50	(49, 51)		Pass 3	77	(73, 84)		Pass 3	77	(73, 84)		Pass 3	77	(73, 84)		Pass 3	14	(14, 16)		Pass 3	24	(22, 30)		Pass 3	1	(1, 1)
	Pass 1	34	(43, 51)		Pass 1	47	(73, 84)		Pass 1	47	(73, 84)		Pass 1	47	(73, 84)		Pass 1	14	(14, 16)		Pass 1	14	(14, 16)		Pass 1	1	(1, 1)
	Pass 2	48	(43, 51)		Pass 2	74	(65, 88)		Pass 2	74	(65, 88)		Pass 2	74	(65, 88)		Pass 2	31	(14, 118)		Pass 2	31	(14, 118)		Pass 2	1	(1, 1)
	Pass 3	50	(49, 51)		Pass 3	77	(73, 84)		Pass 3	77	(73, 84)		Pass 3	77	(73, 84)		Pass 3	14	(14, 16)		Pass 3	14	(14, 16)		Pass 3	1	(1, 1)
	Pass 1	7	(7, 7)		Pass 1	7	(7, 7)		Pass 1	7	(7, 7)		Pass 1	7	(7, 7)		Pass 1	7	(7, 7)		Pass 1	7	(7, 7)		Pass 1	12	(10, 21)
	Pass 2	31	(14, 118)		Pass 2	31	(14, 118)		Pass 2	31	(14, 118)		Pass 2	31	(14, 118)		Pass 2	31	(14, 118)		Pass 2	31	(14, 118)		Pass 2	12	(10, 21)
	Pass 3	14	(14, 16)		Pass 3	14	(14, 16)		Pass 3	14	(14, 16)		Pass 3	14	(14, 16)		Pass 3	14	(14, 16)		Pass 3	14	(14, 16)		Pass 3	14	(12, 22)
Rhiosc ADT	Pass 1	5	(5, 5)	Rhiosc ADT	Pass 1	5	(5, 5)	Rhiosc ADT	Pass 1	5	(5, 5)	Rhiosc ADT	Pass 1	5	(5, 5)	Rhiosc ADT	Pass 1	5	(5, 5)	Rhiosc ADT	Pass 1	5	(5, 5)	Rhiosc ADT	Pass 1	5	(5, 5)
	Pass 2	7	(7, 7)		Pass 2	7	(7, 7)		Pass 2	7	(7, 7)		Pass 2	7	(7, 7)		Pass 2	7	(7, 7)		Pass 2	7	(7, 7)		Pass 2	7	(7, 7)
	Pass 3	12	(10, 21)		Pass 3	12	(10, 21)		Pass 3	12	(10, 21)		Pass 3	12	(10, 21)		Pass 3	12	(10, 21)		Pass 3	12	(10, 21)		Pass 3	12	(10, 21)
	Pass 4	14	(12, 22)		Pass 4	14	(12, 22)		Pass 4	14	(12, 22)		Pass 4	14	(12, 22)		Pass 4	14	(12, 22)		Pass 4	14	(12, 22)		Pass 4	14	(12, 22)
Mical (all)	Pass 1	2	(2, 2)	Cotbai (all)	Pass 1	1	(1, 1)	Cotbai (all)	Pass 1	1	(1, 1)	Cotbai (all)	Pass 1	1	(1, 1)	Cotbai (all)	Pass 1	1	(1, 1)	Cotbai (all)	Pass 1	1	(1, 1)	Cotbai (all)	Pass 1	1	(1, 1)
	Pass 2	2	(2, 2)		Pass 2	1	(1, 1)		Pass 2	1	(1, 1)		Pass 2	1	(1, 1)		Pass 2	1	(1, 1)		Pass 2	1	(1, 1)		Pass 2	1	(1, 1)
	Pass 3	2	(2, 2)		Pass 3	1	(1, 1)																				

2001 Animas River Animas Park Habitat Original Breakdowns

Note: A * in the 95% CI indicates a non-descending removal pattern error

2001 Animas River	Rifle #1	Rifle #2	Rifle #3	Run #1	Run #2	Run #3
	Pop. Est. 95% CI	Pop. Est. 95% CI	Pop. Est. 95% CI	Pop. Est. 95% CI	Pop. Est. 95% CI	Pop. Est. 95% CI
Caddis (all)	Pass 1 1 Pass 2 1 (1, 1) Pass 3 1 (1, 1)	Caddis (all) Pass 1 11 Pass 2 36 Pass 3 120 (34, 504)	Caddis (all) Pass 1 4 Pass 2 8 (7, 15) Pass 3 8 (8, 10)	Caddis (all) Pass 1 14 Pass 2 20 (19, 25) Pass 3 23 (22, 27)	Caddis (all) Pass 1 5 Pass 2 8 (8, 11) Pass 3 9 (9, 11)	Caddis (all) Pass 1 15 Pass 2 28 (23, 42) Pass 3 28 (26, 33)
Caddis JUV	Pass 1 1 Pass 2 1 (1, 1) Pass 3 1 (1, 1)	Caddis YOY Pass 1 5 Pass 2 21 Pass 3 33 *	Caddis YOY Pass 1 2 Pass 2 4 (4, 9) Pass 3 5 (5, 8)	Caddis YOY Pass 1 4 Pass 2 4 (4, 4) Pass 3 6 (6, 9)	Caddis YOY Pass 1 2 Pass 2 3 (3, 6) Pass 3 3 (3, 4)	Caddis YOY Pass 1 13 Pass 2 27 (21, 44) Pass 3 26 (24, 32)
Catfish (all)	Pass 1 1 Pass 2 1 (1, 1) Pass 3 2 (2, 15)	Catfish JUV Pass 1 6 Pass 2 12 (10, 22) Pass 3 13 (12, 18)	Catfish JUV Pass 1 2 Pass 2 3 (3, 6) Pass 3 3 (3, 4)	Catfish JUV Pass 1 10 Pass 2 17 (15, 25) Pass 3 16 (16, 18)	Catfish JUV Pass 1 3 Pass 2 5 (5, 8) Pass 3 6 (6, 9)	Catfish JUV Pass 1 2 Pass 2 2 (2, 2) Pass 3 2 (2, 2)
Catfish YOY	Pass 1 1 Pass 2 1 (1, 1) Pass 3 2 (2, 15)	Catfish YOY Pass 1 22 Pass 2 33 (30, 41) Pass 3 30 (30, 31)	Rhiosc (all) Pass 1 60 Pass 2 97 (84, 114) Pass 3 114 (101, 129)	Catfish YOY Pass 1 8 Pass 2 9 (9, 10) Pass 3 9 (9, 9)	Catfish YOY Pass 1 14 Pass 2 17 (17, 19) Pass 3 17 (17, 18)	Catfish YOY Pass 1 2 Pass 2 2 (2, 2) Pass 3 2 (2, 2)
Rhiosc (all)	Pass 1 28 Pass 2 40 (37, 47) Pass 3 45 (43, 50)	Catfish YOY Pass 1 21 Pass 2 32 (29, 40) Pass 3 29 (29, 30)	Rhiosc JUV Pass 1 60 Pass 2 97 (84, 114) Pass 3 114 (101, 129)	Catfish YOY Pass 1 2 Pass 2 2 (2, 2) Pass 3 2 (2, 2)	Catfish JUV Pass 1 14 Pass 2 17 (17, 19) Pass 3 17 (17, 18)	Catfish YOY Pass 1 2 Pass 2 2 (2, 2) Pass 3 2 (2, 2)
Rhiosc ADT	Pass 1 28 Pass 2 40 (37, 47) Pass 3 45 (43, 50)	Catfish JUV Pass 1 1 Pass 2 1 (1, 1) Pass 3 1 (1, 1)	Rhiosc ADT Pass 1 60 Pass 2 97 (84, 114) Pass 3 112 (100, 126)	Catfish JUV Pass 1 6 Pass 2 7 (7, 8) Pass 3 7 (7, 7)	Rhiosc (all) Pass 1 5 Pass 2 5 (5, 5) Pass 3 5 (5, 5)	Rhiosc (all) Pass 1 32 Pass 2 77 (52, 132) Pass 3 64 (58, 73)
		Rhiosc (all) Pass 1 45 Pass 2 162 (79, 319) Pass 3 91 (84, 103)		Rhiosc (all) Pass 1 12 Pass 2 18 (17, 23) Pass 3 21 (20, 25)	Rhiosc ADT Pass 1 5 Pass 2 5 (5, 5) Pass 3 5 (5, 5)	Rhiosc JUV Pass 1 2 Pass 2 2 (2, 2) Pass 3 2 (2, 2)
		Rhiosc JUV Pass 1 2 Pass 2 4 (4, 9) Pass 3 4 (4, 6)		Rhiosc ADT Pass 1 12 Pass 2 18 (17, 23) Pass 3 21 (20, 25)		Rhiosc ADT Pass 1 30 Pass 2 80 (50, 138) Pass 3 62 (56, 72)
		Rhiosc ADT Pass 1 43 Pass 2 148 (75, 286) Pass 3 87 (80, 97)		Miscal (all) Pass 1 1 Pass 2 1 Pass 3 1 (1, 1)		
				Miscal Juv Pass 1 1 Pass 2 1 Pass 3 1 (1, 1)		
				Lepoysa (all) Pass 1 1 Pass 2 1 (1, 1) Pass 3 1 (1, 1)		
				Lepoysa Juv Pass 1 1 Pass 2 1 (1, 1) Pass 3 1 (1, 1)		

APPENDIX E – Flannelmouth Example Code

LEAKAGE FRACTION = Pred_19_F

NO-LEAK ZONE = 0%

Age0_20_F(t) = Age0_20_F(t - dt) + (Spawning_20_F - Surv_20_F - Mort_Age0_20_F) * dt
 INIT Age0_20_F = 0,0,0,0,0,0,0,0,0,0,0,0,0,0,0,0,1

TRANSIT TIME = varies

INFLOW LIMIT = INF

CAPACITY = INF

Spawning_20_F = (Breeding_F*Eggs_per_female_F)*Hatch_success_F
 Surv_20_F = CONVEYOR OUTFLOW

TRANSIT TIME = IF (TIME<17) THEN 17 ELSE 49
 Mort_Age0_20_F = LEAKAGE OUTFLOW

LEAKAGE FRACTION = Pred_20_F

NO-LEAK ZONE = 0%

Age0_21_F(t) = Age0_21_F(t - dt) + (Spawning_21_F - Surv_21_F - Mort_Age0_21_F) * dt
 INIT Age0_21_F = 0,0,0,0,0,0,0,0,0,0,0,0,0,0,0,0,1

TRANSIT TIME = varies

INFLOW LIMIT = INF

CAPACITY = INF

Spawning_21_F = (Breeding_F*Eggs_per_female_F)*Hatch_success_F
 Surv_21_F = CONVEYOR OUTFLOW

TRANSIT TIME = IF (TIME<17) THEN 17 ELSE 48
 Mort_Age0_21_F = LEAKAGE OUTFLOW

LEAKAGE FRACTION = Pred_21_F

NO-LEAK ZONE = 0%

Age0_22_F(t) = Age0_22_F(t - dt) + (Spawning_22_F - Surv_22_F - Mort_Age0_22_F) * dt
 INIT Age0_22_F = 0,0,0,0,0,0,0,0,0,0,0,0,0,0,0,0,1

TRANSIT TIME = varies

INFLOW LIMIT = INF

CAPACITY = INF

Spawning_22_F = (Breeding_F*Eggs_per_female_F)*Hatch_success_F
 Surv_22_F = CONVEYOR OUTFLOW

TRANSIT TIME = IF (TIME<17) THEN 17 ELSE 47
 Mort_Age0_22_F = LEAKAGE OUTFLOW

LEAKAGE FRACTION = Pred_22_F

NO-LEAK ZONE = 0%

Age0_23_F(t) = Age0_23_F(t - dt) + (Spawning_23_F - Surv_23_F - Mort_Age0_23_F) * dt

INIT Age0_23_F = 0,0,0,0,0,0,0,0,0,0,0,0,0,0,0,0,1

TRANSIT TIME = varies

INFLOW LIMIT = INF

CAPACITY = INF

Spawning_23_F = (Breeding_F * Eggs_per_female_F) * Hatch_success_F

Surv_23_F = CONVEYOR OUTFLOW

TRANSIT TIME = IF (TIME < 17) THEN 17 ELSE 46

Mort_Age0_23_F = LEAKAGE OUTFLOW

LEAKAGE FRACTION = Pred_23_F

NO-LEAK ZONE = 0%

Age_1F(t) = Age_1F(t - dt) + (Surv_19_F + Surv_20_F + Surv_21_F + Surv_22_F + Surv_23_F +

Surv_18_F - Surv_1F - Mort_1F) * dt

INIT Age_1F = 0,0,0,0,1

TRANSIT TIME = varies

INFLOW LIMIT = INF

CAPACITY = INF

Surv_19_F = CONVEYOR OUTFLOW

TRANSIT TIME = IF (TIME < 17) THEN 17 ELSE 50

Surv_20_F = CONVEYOR OUTFLOW

TRANSIT TIME = IF (TIME < 17) THEN 17 ELSE 49

Surv_21_F = CONVEYOR OUTFLOW

TRANSIT TIME = IF (TIME < 17) THEN 17 ELSE 48

Surv_22_F = CONVEYOR OUTFLOW

TRANSIT TIME = IF (TIME < 17) THEN 17 ELSE 47

Surv_23_F = CONVEYOR OUTFLOW

TRANSIT TIME = IF (TIME < 17) THEN 17 ELSE 46

Surv_18_F = CONVEYOR OUTFLOW

TRANSIT TIME = IF (TIME < 17) THEN 17 ELSE 51

Surv_1F = CONVEYOR OUTFLOW

TRANSIT TIME = IF (TIME < 5) THEN 5 ELSE 12

Mort_1F = LEAKAGE OUTFLOW

LEAKAGE FRACTION = NMrate_JF + Pred_Mrate_J1F

NO-LEAK ZONE = 0%

Age_2F(t) = Age_2F(t - dt) + (Surv_1F - Surv_2F - Mort_2F) * dt

INIT Age_2F = 0,0,0,0,1

TRANSIT TIME = varies

INFLOW LIMIT = INF

 CAPACITY = INF
 Surv_1F = CONVEYOR OUTFLOW

 TRANSIT TIME = IF(TIME<5) THEN 5 ELSE 12
 Surv_2F = CONVEYOR OUTFLOW

 TRANSIT TIME = IF(TIME<5) THEN 5 ELSE 12
 Mort_2F = LEAKAGE OUTFLOW

 LEAKAGE FRACTION = Pred_Mrate_J2F+NMrate_JF

 NO-LEAK ZONE = 0%
 Age_3F(t) = Age_3F(t - dt) + (Surv_2F - Surv_3F - Mort_3F) * dt
 INIT Age_3F = 0,0,0,0,1

 TRANSIT TIME = varies

 INFLOW LIMIT = INF

 CAPACITY = INF
 Surv_2F = CONVEYOR OUTFLOW

 TRANSIT TIME = IF(TIME<5) THEN 5 ELSE 12
 Surv_3F = CONVEYOR OUTFLOW

 TRANSIT TIME = IF(TIME<5) THEN 5 ELSE 12
 Mort_3F = LEAKAGE OUTFLOW

 LEAKAGE FRACTION = NMrate_JF

 NO-LEAK ZONE = 0%
 Age_4F(t) = Age_4F(t - dt) + (Surv_3F - Surv_4F - Mort_4F) * dt
 INIT Age_4F = 0,0,0,0,1

 TRANSIT TIME = varies

 INFLOW LIMIT = INF

 CAPACITY = INF
 Surv_3F = CONVEYOR OUTFLOW

 TRANSIT TIME = IF(TIME<5) THEN 5 ELSE 12
 Surv_4F = CONVEYOR OUTFLOW

 TRANSIT TIME = IF(TIME<5) THEN 5 ELSE 12
 Mort_4F = LEAKAGE OUTFLOW

 LEAKAGE FRACTION = NMrate_JF

 NO-LEAK ZONE = 0%
 Age_5F(t) = Age_5F(t - dt) + (Surv_4F - Surv_5F - Mort_5F) * dt
 INIT Age_5F = 0,0,0,0,1

TRANSIT TIME = varies

 INFLOW LIMIT = INF

 CAPACITY = INF
 Surv_4F = CONVEYOR OUTFLOW

 TRANSIT TIME = IF(TIME<5) THEN 5 ELSE 12
 Surv_5F = CONVEYOR OUTFLOW

 TRANSIT TIME = IF(TIME<5) THEN 5 ELSE 12
 Mort_5F = LEAKAGE OUTFLOW

 LEAKAGE FRACTION = NMrate_J5F

 NO-LEAK ZONE = 0%
 NMrate_AF = 0
 NMrate_J5F = Rate_to_reach_F_carry_cap
 NMrate_JF = 0
 Pred_18_F = { Place right hand side of equation here... }
 Pred_19_F = { Place right hand side of equation here... }
 Pred_20_F = { Place right hand side of equation here... }
 Pred_21_F = { Place right hand side of equation here... }
 Pred_22_F = { Place right hand side of equation here... }
 Pred_23_F = { Place right hand side of equation here... }
 Pred_Mrate_J1F = Juv_1FPred_Rate
 Pred_Mrate_J2F = Juv_2FPred_Rate
 Total_Juv_F = Age_3F + Age_1F + Age_2F + Age_4F + Age_5F
 F Feedback
 Juv_F_Carry_Cap = 27000
 Rate_to_reach_F_carry_cap = (Total_Juv_B-Juv_F_Carry_Cap)/Age_1B
 F Spawning
 Breeding_F = round (Adult_F*Sex_Ratio_F)
 Eggs_per_female_F = 0
 Hatch_success_F = 0
 Sex_Ratio_F = .5
 Juv 1F Pred
 Juv_1F_Pop(t) = Juv_1F_Pop(t - dt) + (Juv_1F_inflow - Juv_1F_dump) * dt
 INIT Juv_1F_Pop = 0,0,0,0,8000

 TRANSIT TIME = varies

 INFLOW LIMIT = INF

 CAPACITY = INF
 Juv_1F_inflow = Surv_0F
 Juv_1F_dump = CONVEYOR OUTFLOW

 TRANSIT TIME = IF (TIME<5) THEN 5 ELSE 12
 J3CP_Pred_Switch_Juv1F = { Place right hand side of equation here... }
 Juv_1FPred_Rate = IF (TIME<6) THEN
 (((Juv_Predator_Food_Req*Pred_Juv1_Diet_3)/Juv_1F_g_Conv)*Juv_1B_Rel_Abun)/Juv_1F_Pop)*5
 ELSE
 (((Juv_Predator_Food_Req*Pred_Juv1_Diet_3)/Juv_1F_g_Conv)*Juv_1B_Rel_Abun)/Juv_1F_Pop)*12

```

INFLOW LIMIT = INF

CAPACITY = INF
YOY_F_Pop(t) = YOY_F_Pop(t - dt) + (YOY_F_inflow - YOY_F_dump) * dt
INIT YOY_F_Pop = 0,0,0,0,8000

TRANSIT TIME = varies

INFLOW LIMIT = INF

CAPACITY = INF
YOY_F_inflow = Egg_hatching_F
YOY_F_dump = CONVEYOR OUTFLOW

TRANSIT TIME = IF (TIME<5) THEN 5 ELSE 12
J3CP_Pred_Switch_YOYF = { Place right hand side of equation here... }
RS_0_Rel_Ab = Age_0B/Total_RS_Prey
Total_Juveniles_3_CP = Age_3CP + Age_4CP + Age_5CP + Age_6CP + Age_7CP
YOY_FPred_Rate = IF (TIME<6) THEN
(((Juv_Predator_Food_Req*Pred_Juv1_Diet_2)/Juv_1B_g_Conv_2)*Juv_1B_Rel_Abun)/YOY_F_Pop)*
5 ELSE
(((Juv_Predator_Food_Req*Pred_Juv1_Diet_2)/Juv_1B_g_Conv_2)*Juv_1B_Rel_Abun)/YOY_F_Pop)*
12
YOY_F_cons_CP =
round((((Adult_RS*Adult_CP_Diet_Requ_4)/YOY_F_Av_Wt)*RS_0B_Rel_Ab)*CP_Pred_Switch_YOY
F)
YOY_F_cons_J2CP = { Place right hand side of equation here... }
YOY_F_cons_J3CP = { Place right hand side of equation here... }
YOY_F_cons_RS =
round((((Adult_RS*Adult_RS_Diet_Requ_2)/YOY_F_Av_Wt)*RS_0_Rel_Ab)*RS_Pred_Switch_YOYF)
Adult_CP_Diet_Requ = GRAPH(counter(1,12))
(1.00, 0.00), (2.00, 0.00), (3.00, 0.00), (4.00, 0.00), (5.00, 0.00), (6.00, 0.00), (7.00, 0.00), (8.00, 0.00),
(9.00, 0.00), (10.0, 0.00), (11.0, 0.00), (12.0, 0.00)
Adult_RS_Diet_Requ = GRAPH(counter(1,12))
(1.00, 0.00), (2.00, 0.00), (3.00, 0.00), (4.00, 0.00), (5.00, 0.00), (6.00, 0.00), (7.00, 0.00), (8.00, 0.00),
(9.00, 0.00), (10.0, 0.00), (11.0, 0.00), (12.0, 0.00)
CP_Pred_Switch_YOYF = GRAPH(counter(1,12))
(1.00, 0.00), (2.00, 0.00), (3.00, 0.00), (4.00, 0.00), (5.00, 0.00), (6.00, 1.00), (7.00, 0.00), (8.00, 0.00),
(9.00, 0.00), (10.0, 0.00), (11.0, 0.00), (12.0, 0.00)
J2_Pred_Switch_YOYF = GRAPH(counter(1,12))
(1.00, 0.00), (2.00, 0.00), (3.00, 0.00), (4.00, 0.00), (5.00, 0.00), (6.00, 0.00), (7.00, 0.00), (8.00, 0.00),
(9.00, 0.00), (10.0, 0.00), (11.0, 0.00), (12.0, 0.00)
Juv2_CP_Diet_Requ = GRAPH(counter(1,12))
(1.00, 0.00), (2.00, 0.00), (3.00, 0.00), (4.00, 0.00), (5.00, 0.00), (6.00, 0.00), (7.00, 0.00), (8.00, 0.00),
(9.00, 0.00), (10.0, 0.00), (11.0, 0.00), (12.0, 0.00)
Juv3_CP_Diet_Requ = GRAPH(COUNTER(1,12))
(1.00, 0.00), (2.00, 0.00), (3.00, 0.00), (4.00, 0.00), (5.00, 0.00), (6.00, 0.00), (7.00, 0.00), (8.00, 0.00),
(9.00, 0.00), (10.0, 0.00), (11.0, 0.00), (12.0, 0.00)
RS_Pred_Switch_YOYF = GRAPH(counter(1,12))
(1.00, 0.00), (2.00, 0.00), (3.00, 0.00), (4.00, 0.00), (5.00, 0.00), (6.00, 1.00), (7.00, 0.00), (8.00, 0.00),
(9.00, 0.00), (10.0, 0.00), (11.0, 0.00), (12.0, 0.00)
YOY_F_Av_Wt = GRAPH(COUNTER(1,12))
(1.00, 0.00), (2.00, 0.00), (3.00, 0.00), (4.00, 0.00), (5.00, 0.00), (6.00, 0.00), (7.00, 0.00), (8.00, 0.00),
(9.00, 0.00), (10.0, 0.00), (11.0, 0.00), (12.0, 0.00)

```



Miller Ecological Consultants, Inc.
2111 S. College Avenue, Unit D
Fort Collins, Colorado 80525
970-224-4505